

Beam Backgrounds and Shielding

Seonho Choi
Seoul National University

SANE Readiness Review
July 2, 2007

Simulation Model

- Pavel's program to simulate backgrounds from the beamline
- Glen added BETA detector configuration
- BETA detector geometry updated for the new design (at least for Cerenkov)
- Updated to be compiled and run with GEANT₄ package
- Test of various configuration of shielding

Beam backgrounds

- At parallel configuration
 - Most backgrounds are from the target exit window - PMT's are relatively safe

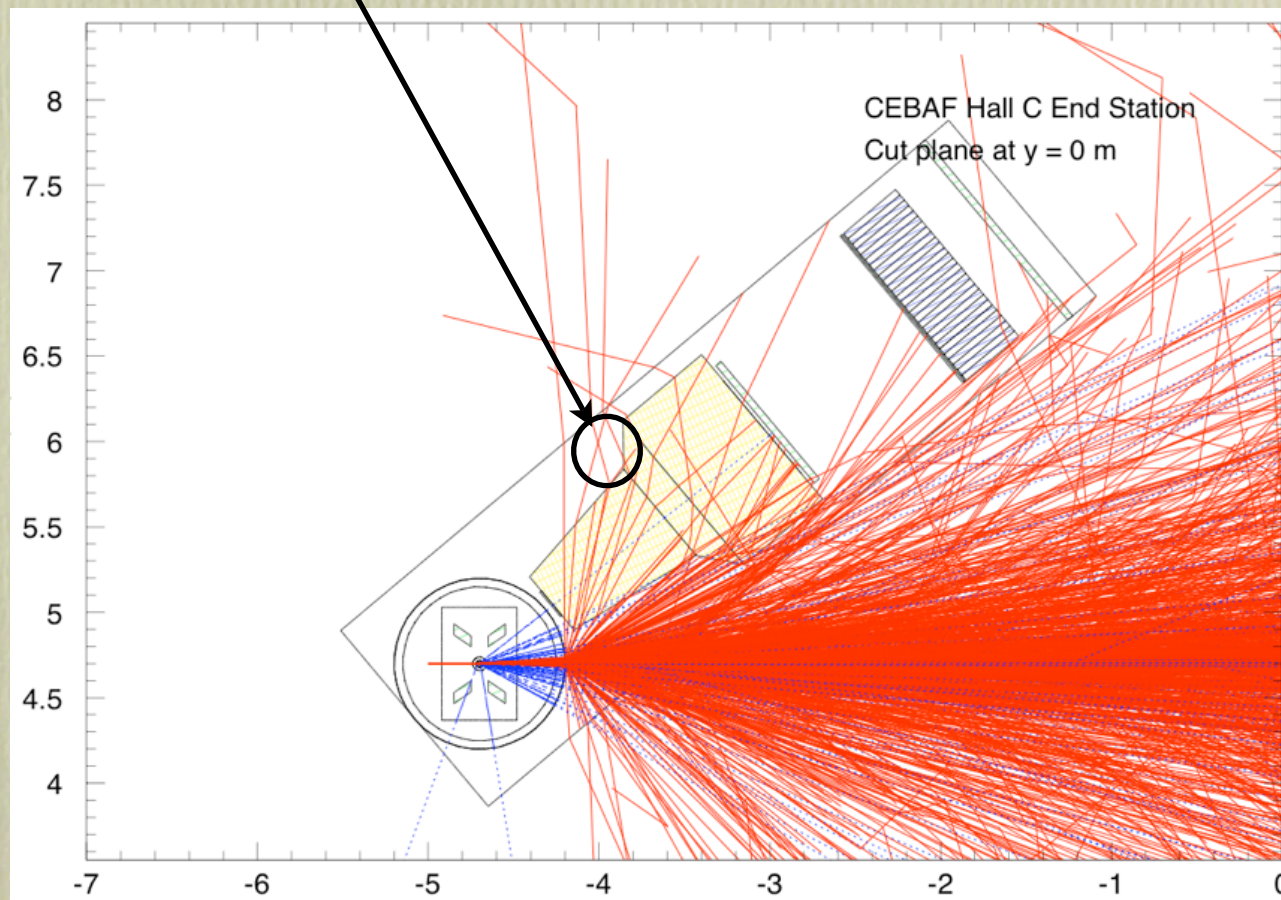

Backgrounds (cont.)

- At perpendicular configuration
 - Backgrounds from the target cell - major contribution to PMT stacks

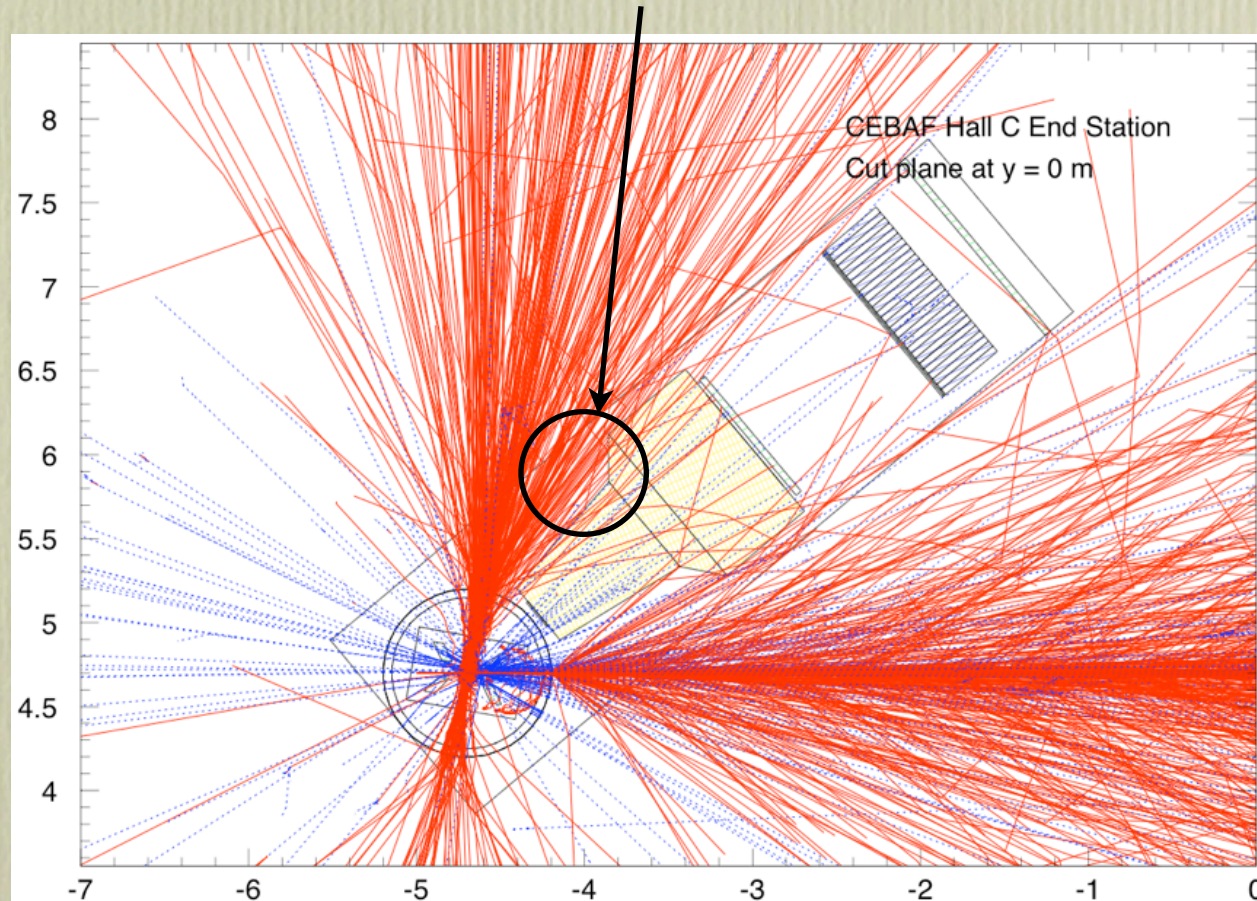

Shielding for beamline side

- Continuous Pb wall of thickness 10cm

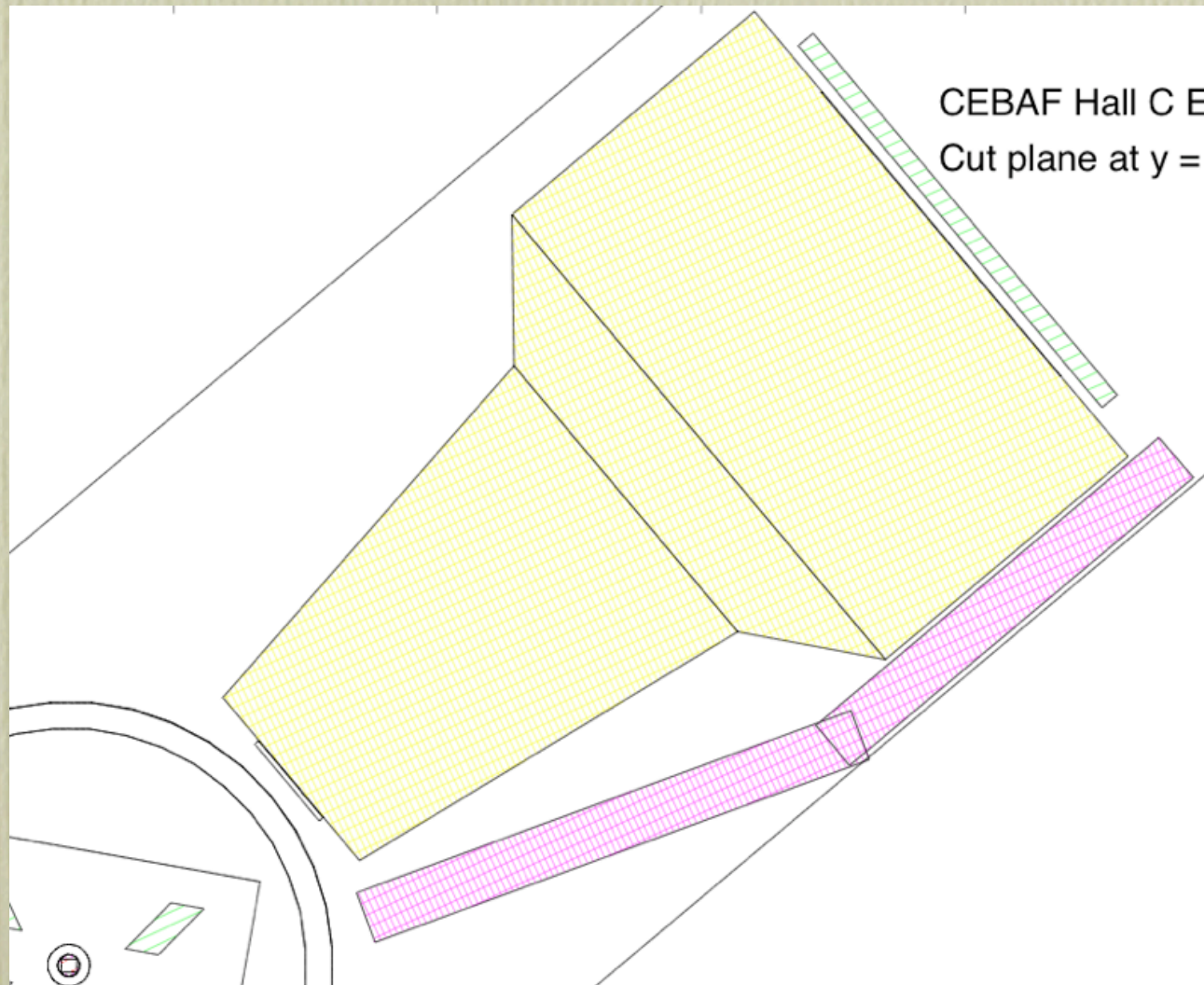

Shielding for PMT side

- 15cm thick Pb wall in front of PMT stack

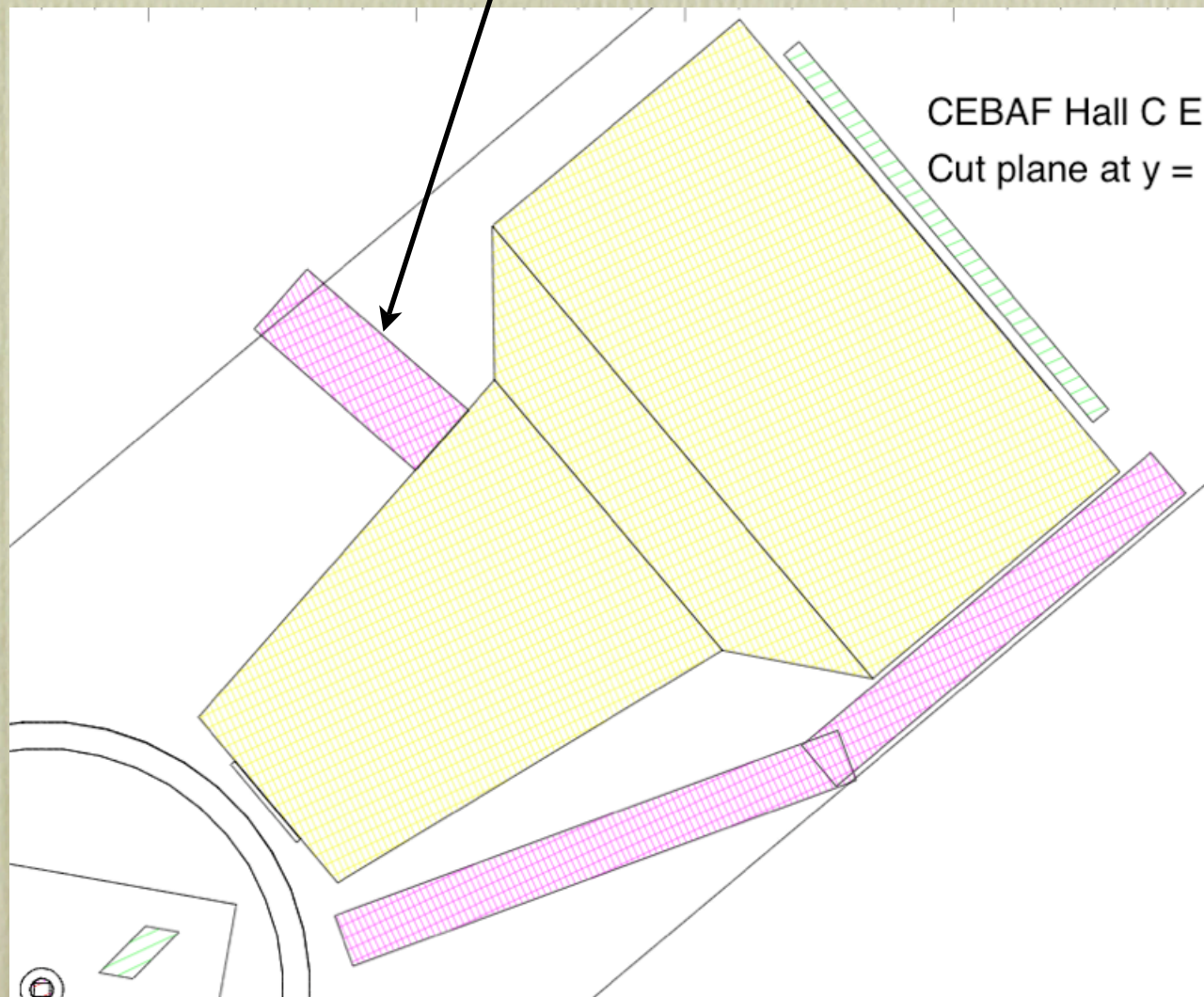

Results for parallel configuration

- The beam background is not an issue.

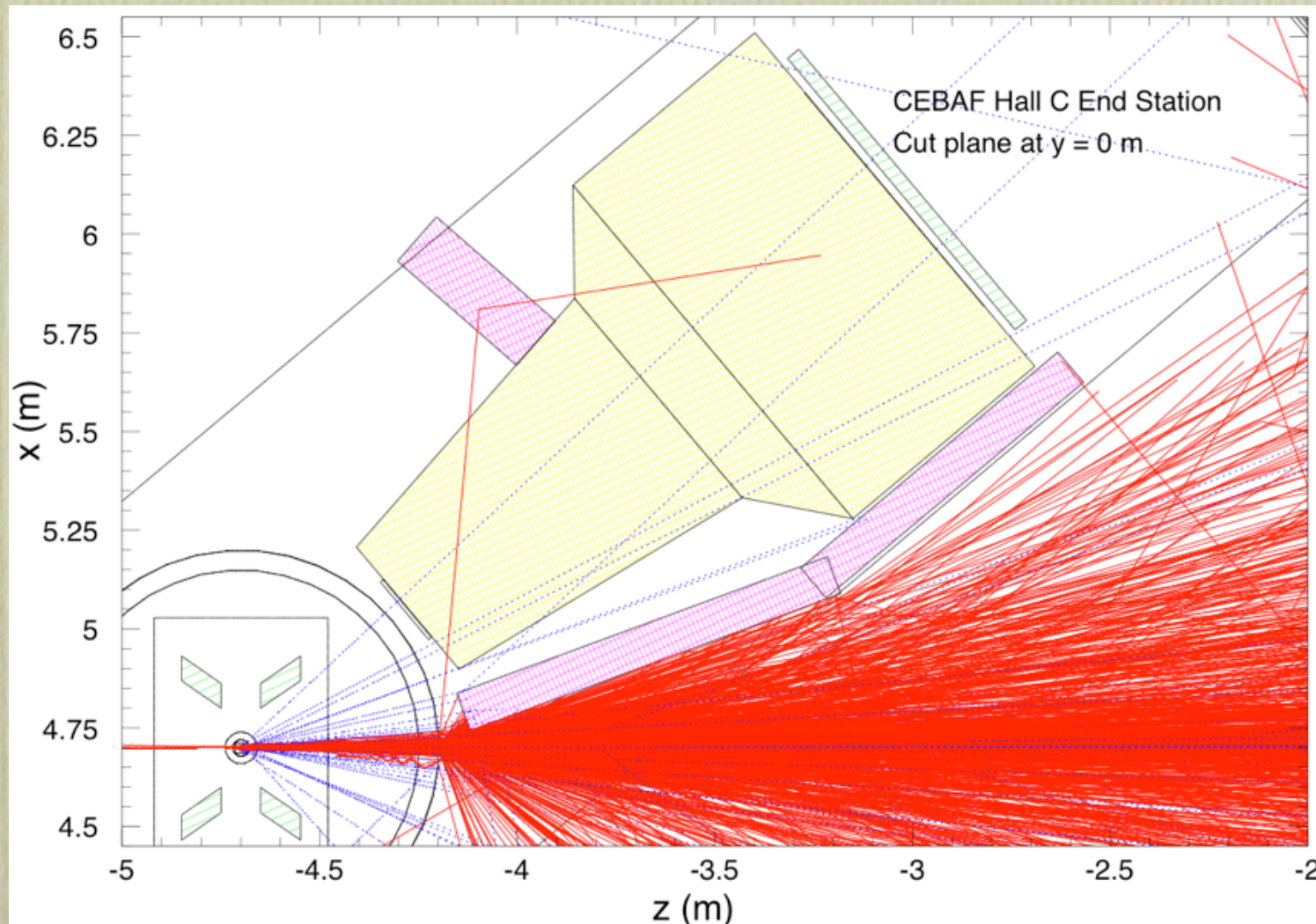

Perpendicular Configuration

- Some charged particles hitting Cerenkov

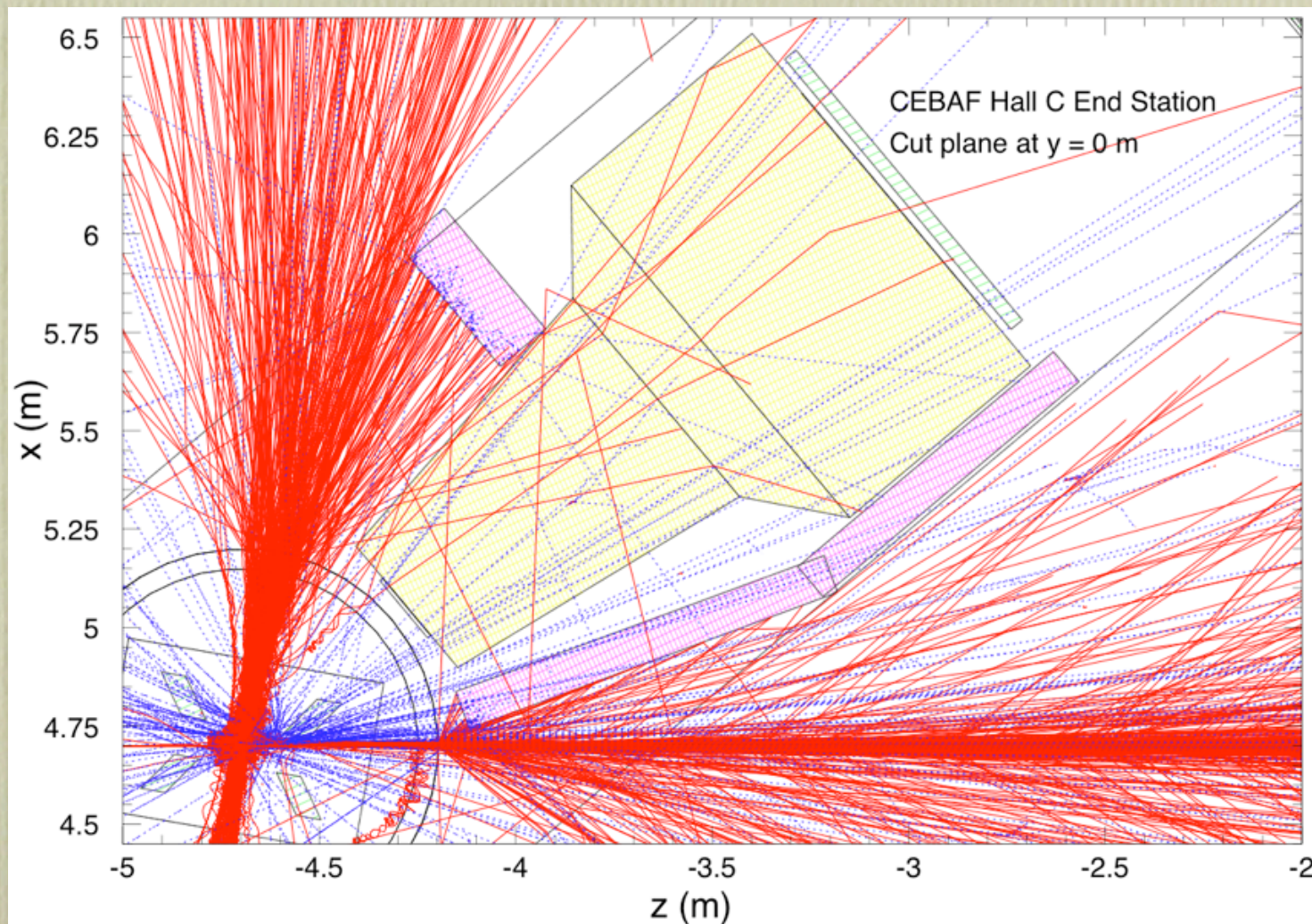

Perpendicular configuration

- The background from the target cell is a major issue.
- Single 15cm wall in front of PMT's is quite an effective shielding.
- Second shielding necessary to reduce charged particles inside the Cerenkov tank.

Additional Shielding

- 10cm Pb wall along the side of the Cerenkov

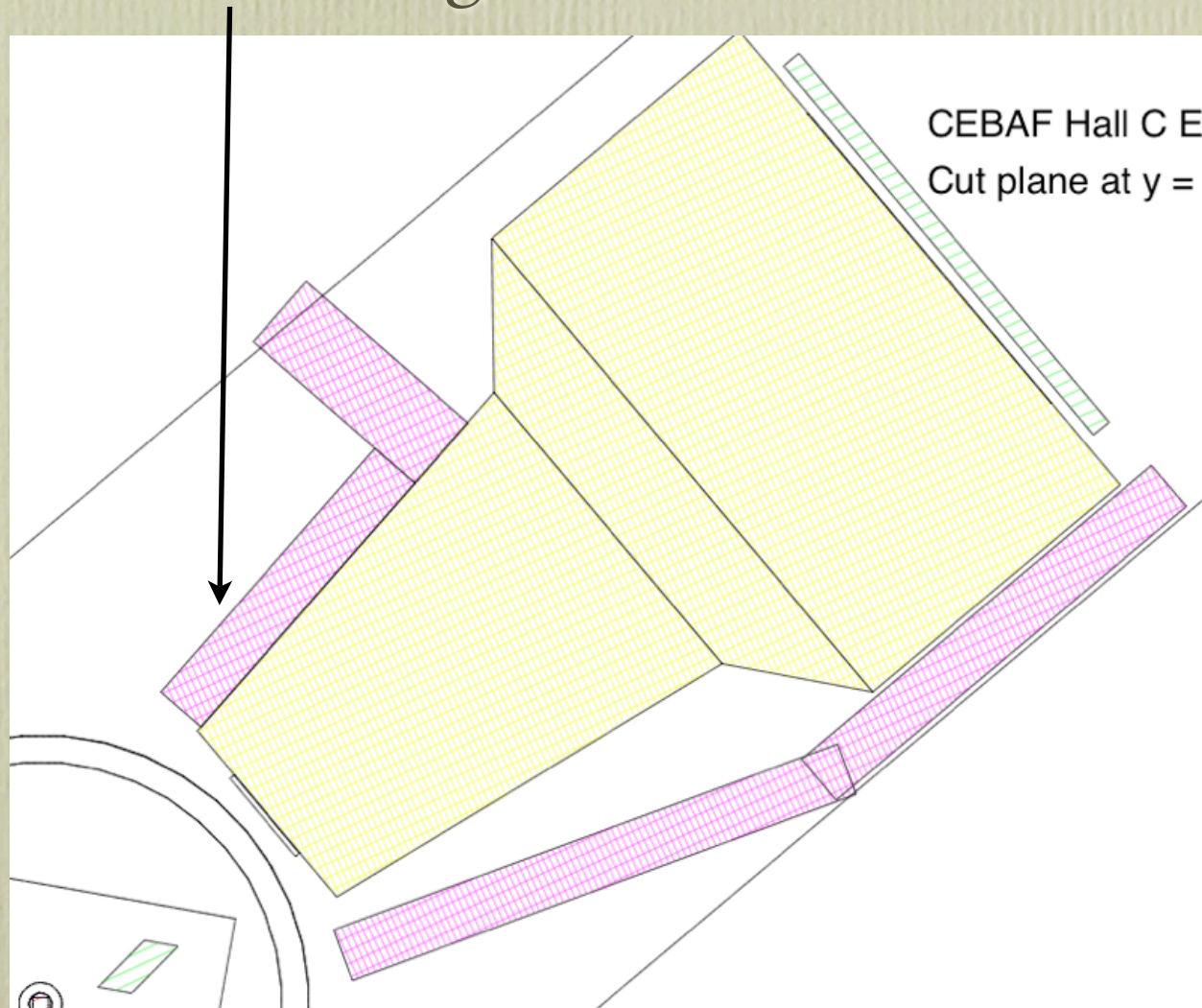

PMT Stack

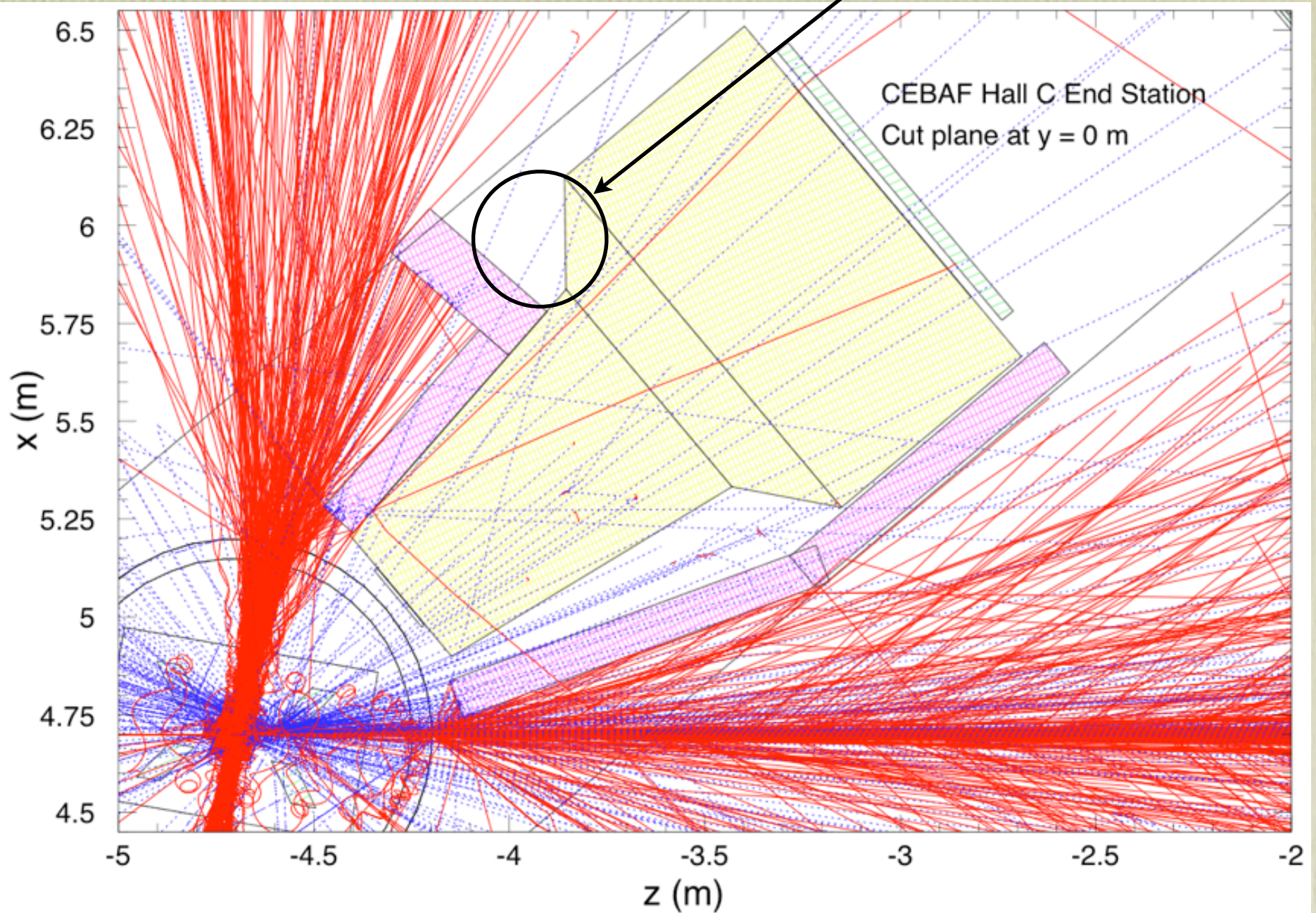

15cm thick Pb wall on SOS pivot

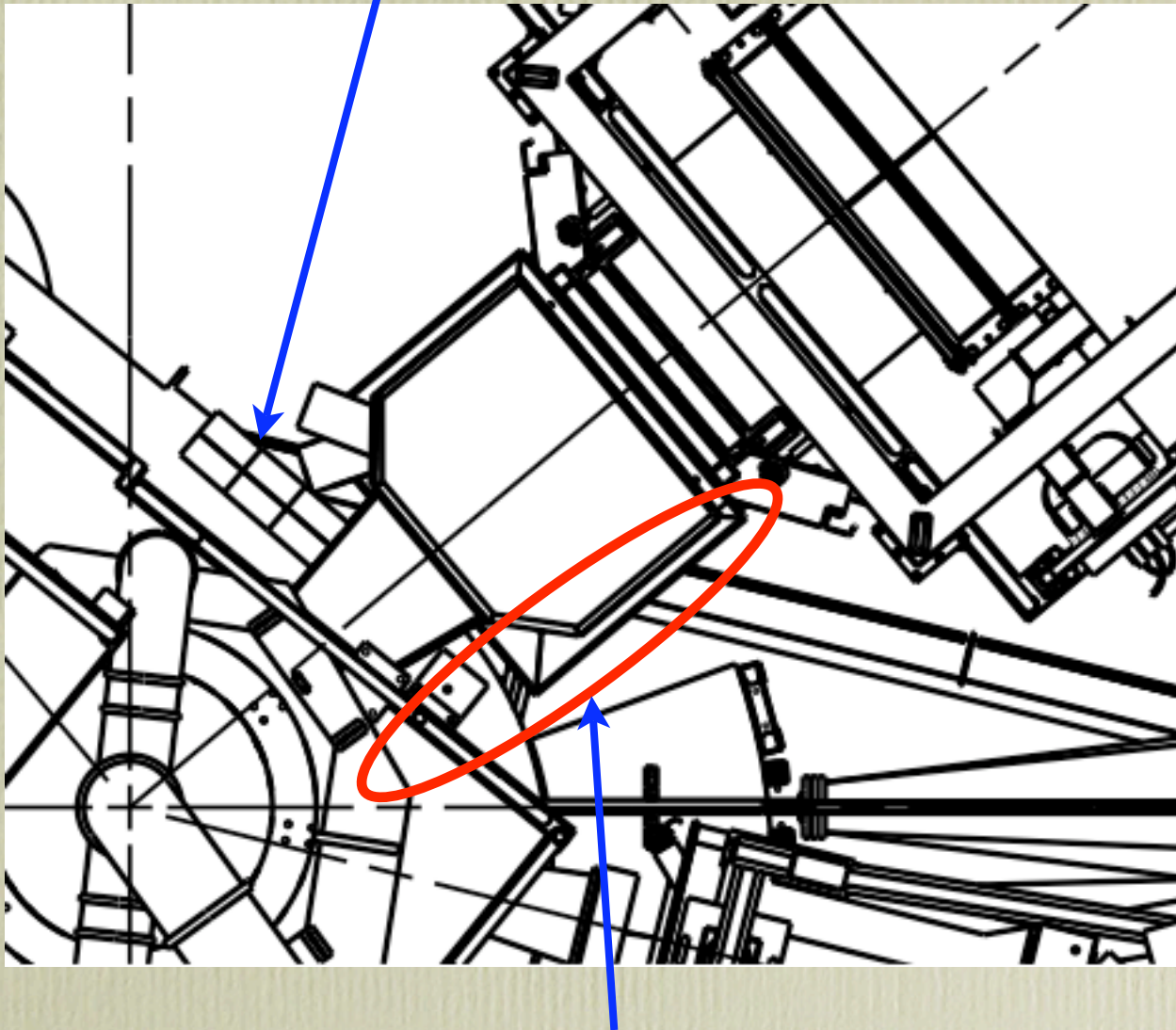

Not enough space for shielding

Pb wall on SOS pivot only

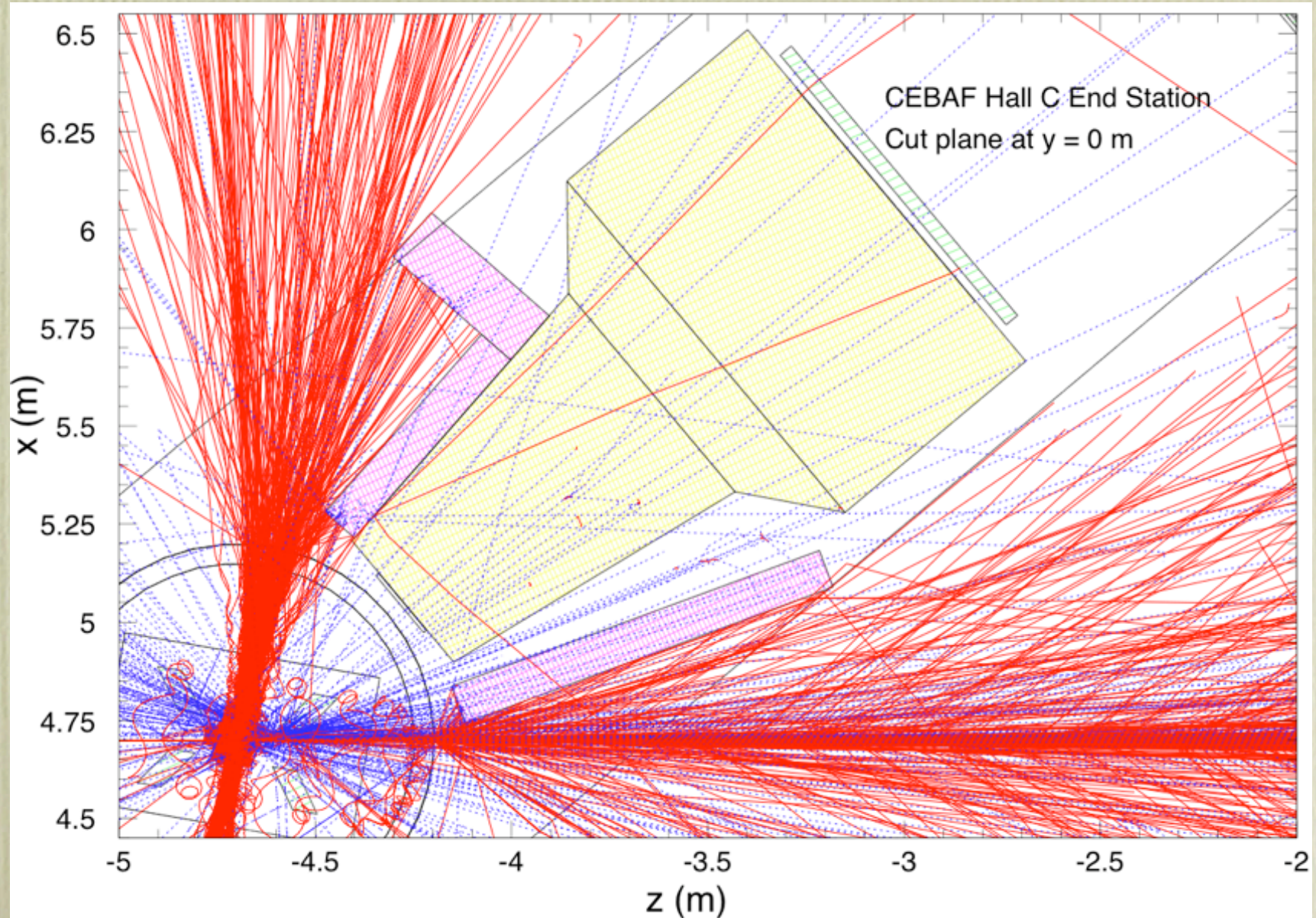

Conclusions

- Usual Pb walls at various locations are quite effective for the protection of PMT's at both target magnet configurations
- Desirable to use thicker Pb wall in front the PMT's
- Possible to place all the essential shields on SOS pivot
- With proper shielding, **beam backgrounds are not an issue for SANE.**