

***Strange Hadron Spectroscopy with
Secondary KL Beam in Hall D***

Moskov Amaryan

*Old Dominion University
Norfolk, VA*

GlueX-PANDA Workshop, May 3-5, 2019, GWU, Washington DC

Outline

Current Status

- *Hyperon Spectroscopy*
- *Strange Meson Spectroscopy*

Future Prospects with K_L Facility at JLab

- *Electron Beam*
- *Compact Photon Source*
- *Be Target*
- *Flux Monitor*
- *K_L Beam*
- *LH_2/LD_2 Target*

Summary

Hyperon Spectroscopy

According to *LQCD* there should be many more states including hybrids (thick bordered)

8-states

5-states

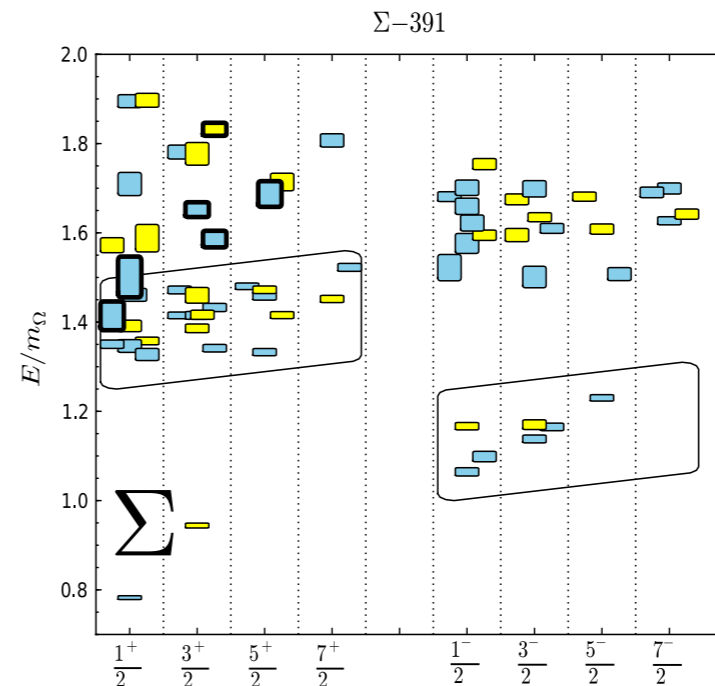
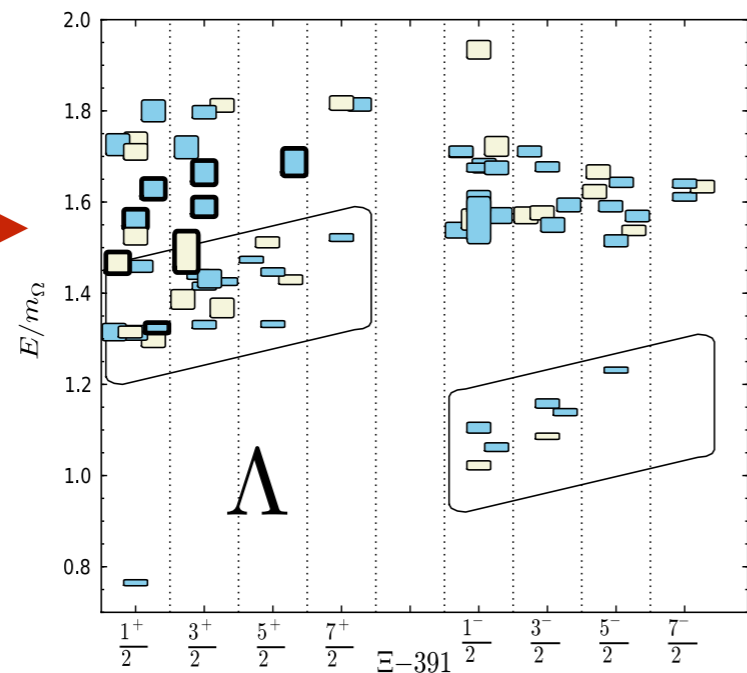

6-states

4-states

3-states

4-states

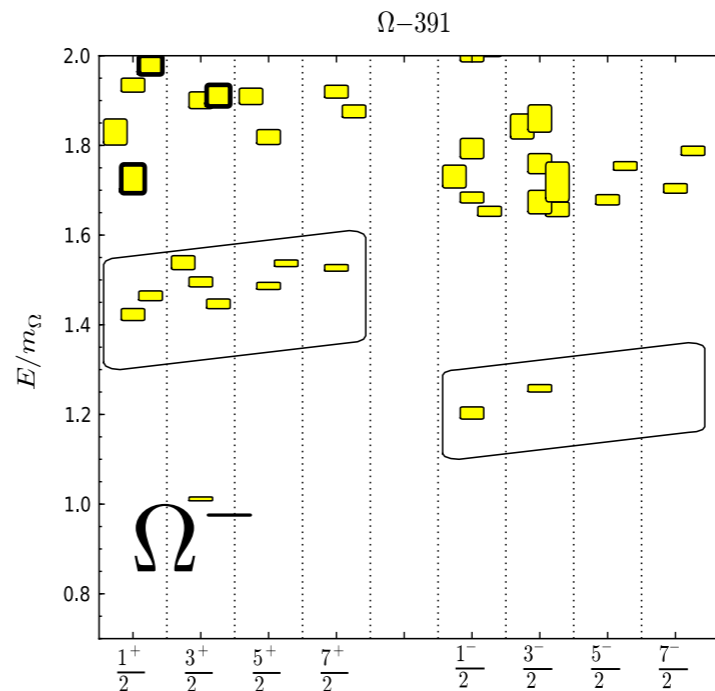
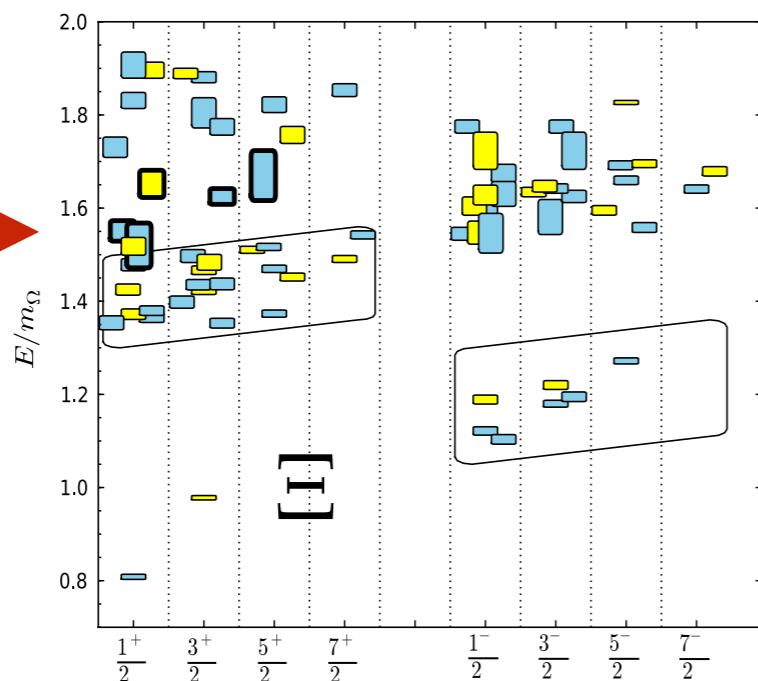

1-state

1-state

Edwards, Mathur, Richards and Wallace, *Phys. Rev. D* 87, 054506 (2013)

Measurements on Proton Target

existing data

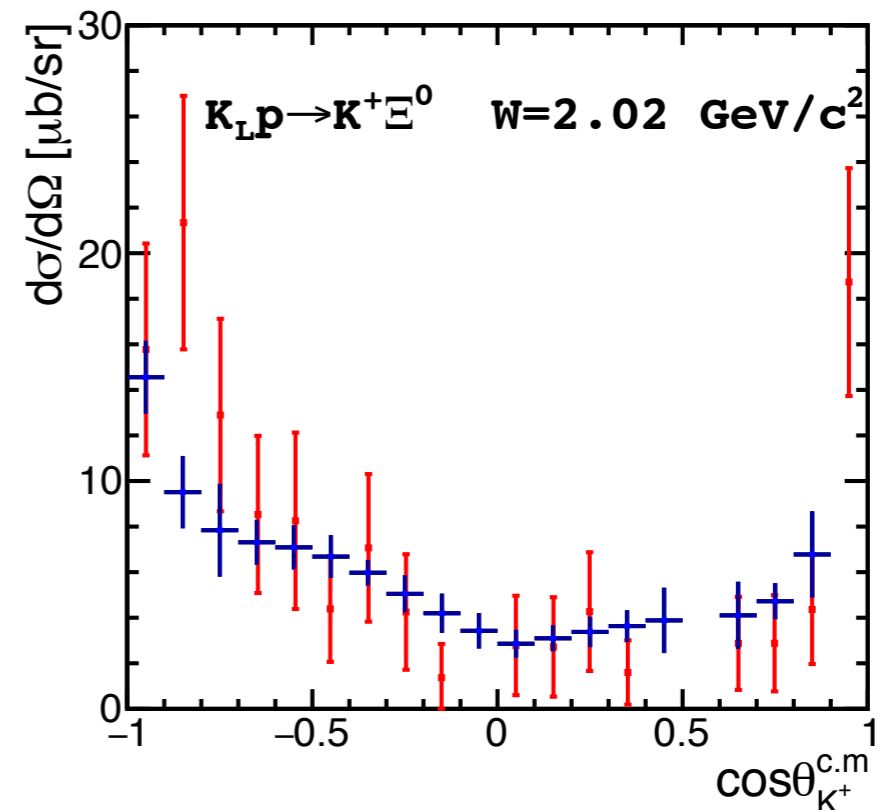
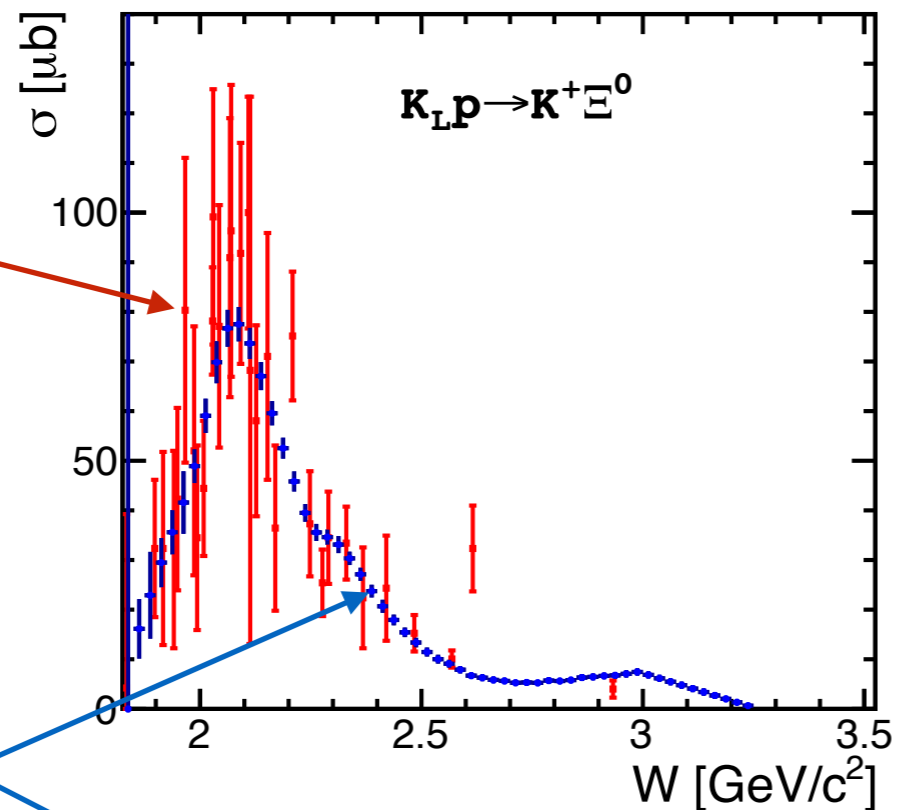

KLF 100 days

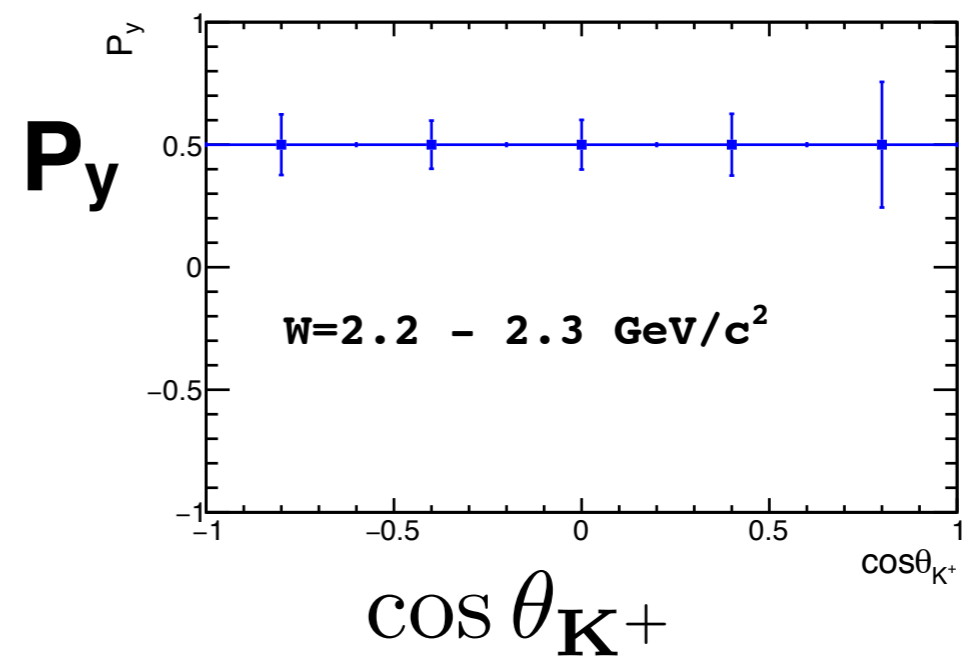
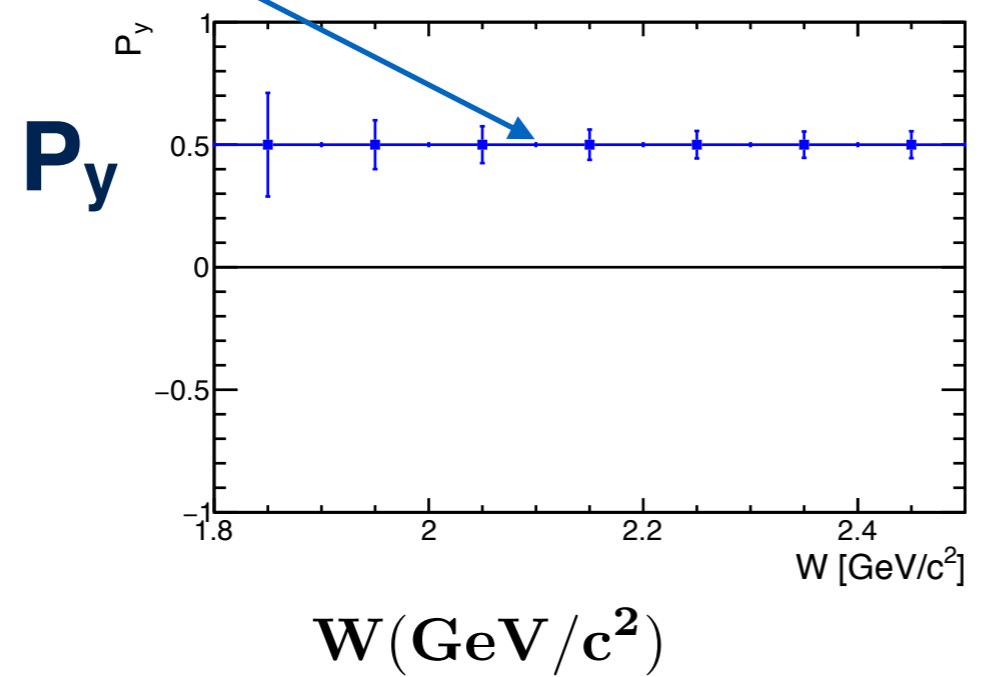

Search for Hyperon Resonances with PWA

For Scattering experiments on both proton & neutron targets one needs to determine:

- differential cross sections**
- self polarization of strange hyperons**
- perform coupled-channel PWA**
- look for poles in complex energy plane
(contrary to naïve bump hunting)**
- identify all Λ^* , Σ^* , Ξ^* & Ω^* up to 2400 MeV**

**we use KN scattering data with statistics
generated according to expected K-long Facility (KLF)
data for 20 and 100 days to show PWA sensitivity
to obtain results close to the best fit**

Bonn-Gatchina PWA

Total Cross Section

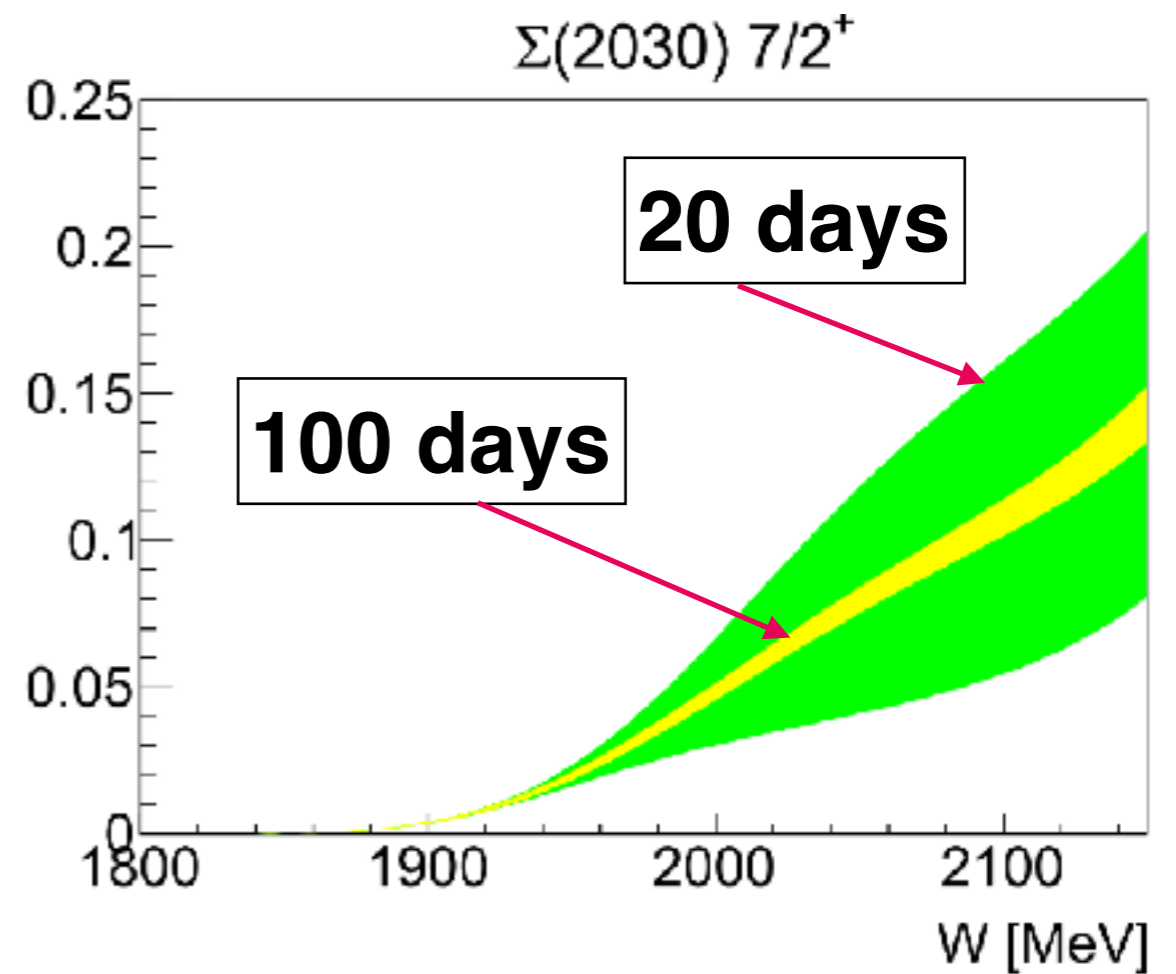
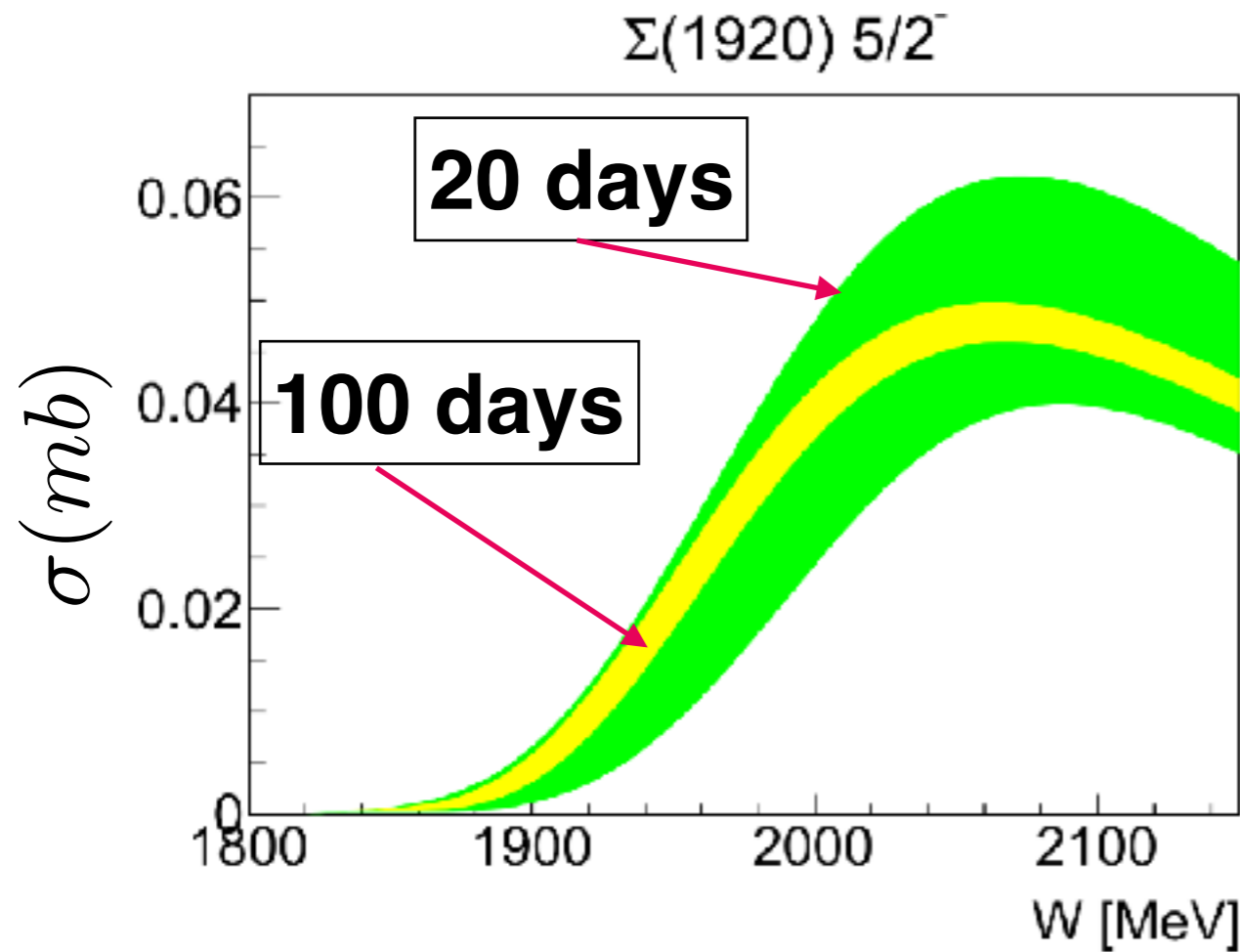
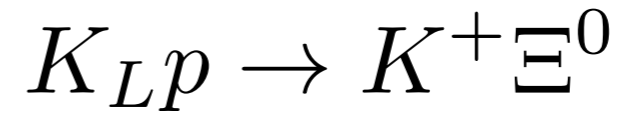

Obviously: **at least 100 days** needed to get precise solution

Bonn-Gatchina PWA

Diff. Cross Section

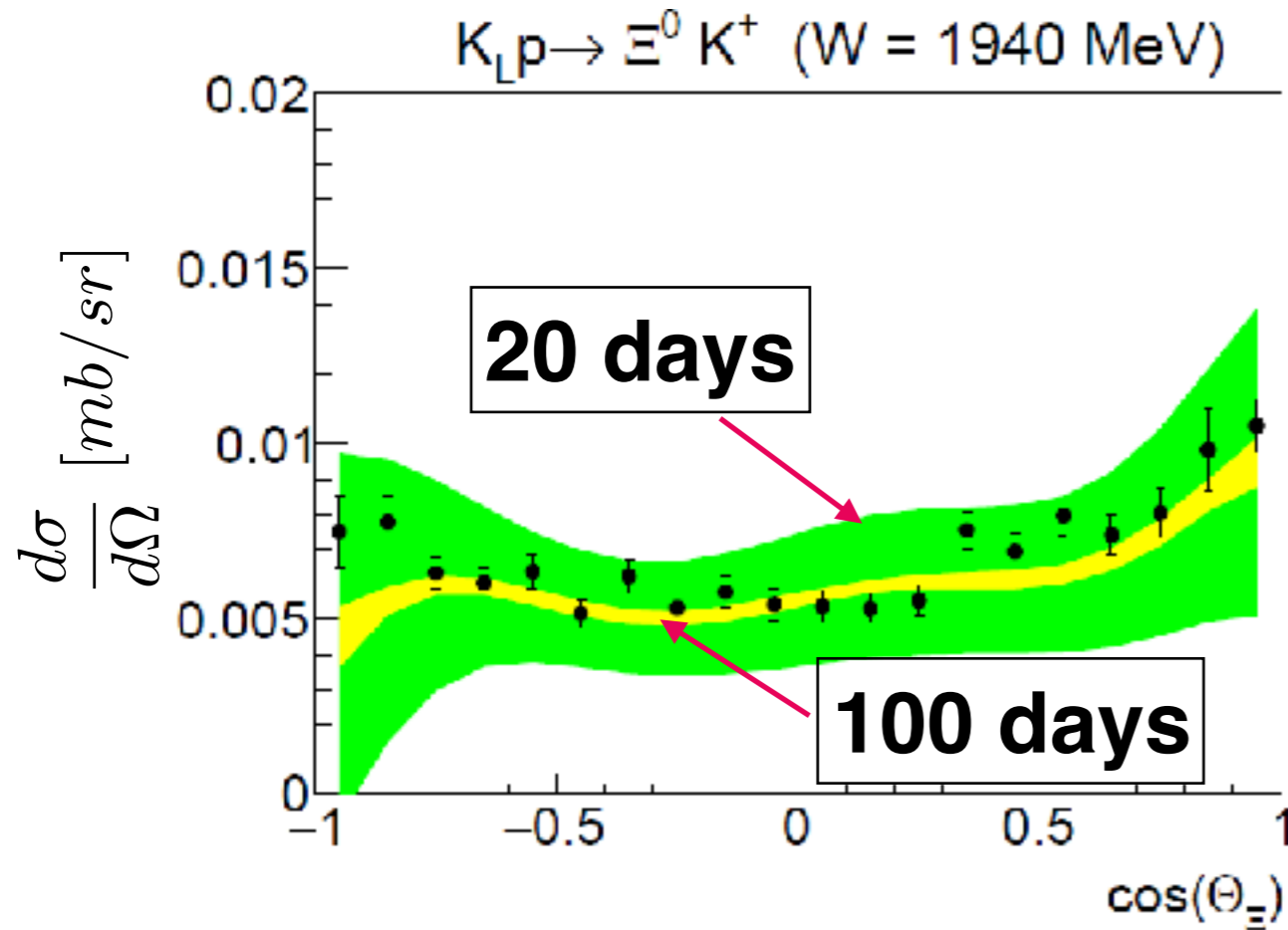

Polarization

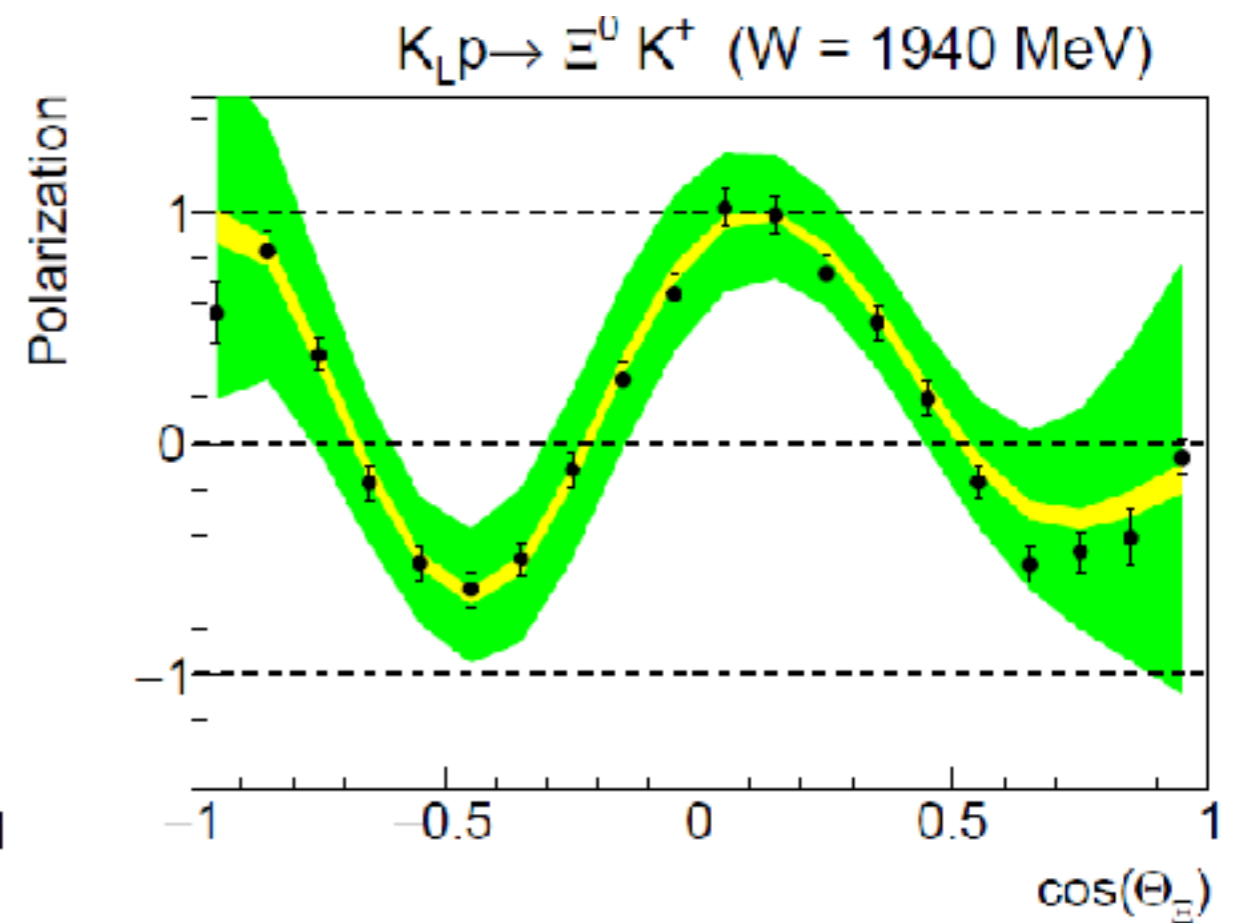

Again: **at least 100 days** to get precise solution

Some Numerical Results

Simulated $\Sigma(1920) \ 5/2^-$



$$\left\{ \begin{array}{l} 100d \ M = \underline{1.923} \pm 0.010 \pm 0.010 \text{ GeV} \\ \quad \Gamma = 0.321 \pm 0.01 \pm 0.010 \text{ GeV} \\ 20d \ M = \underline{1.977} \pm 0.021 \pm 0.025 \text{ GeV} \\ \quad \Gamma = 0.327 \pm 0.025 \pm 0.025 \text{ GeV} \end{array} \right.$$

$$PDG2018 \ M = 1.775 \pm 0.005$$

$$LQCD \ M = 1.212 \text{ GeV}$$

Strange Meson Spectroscopy

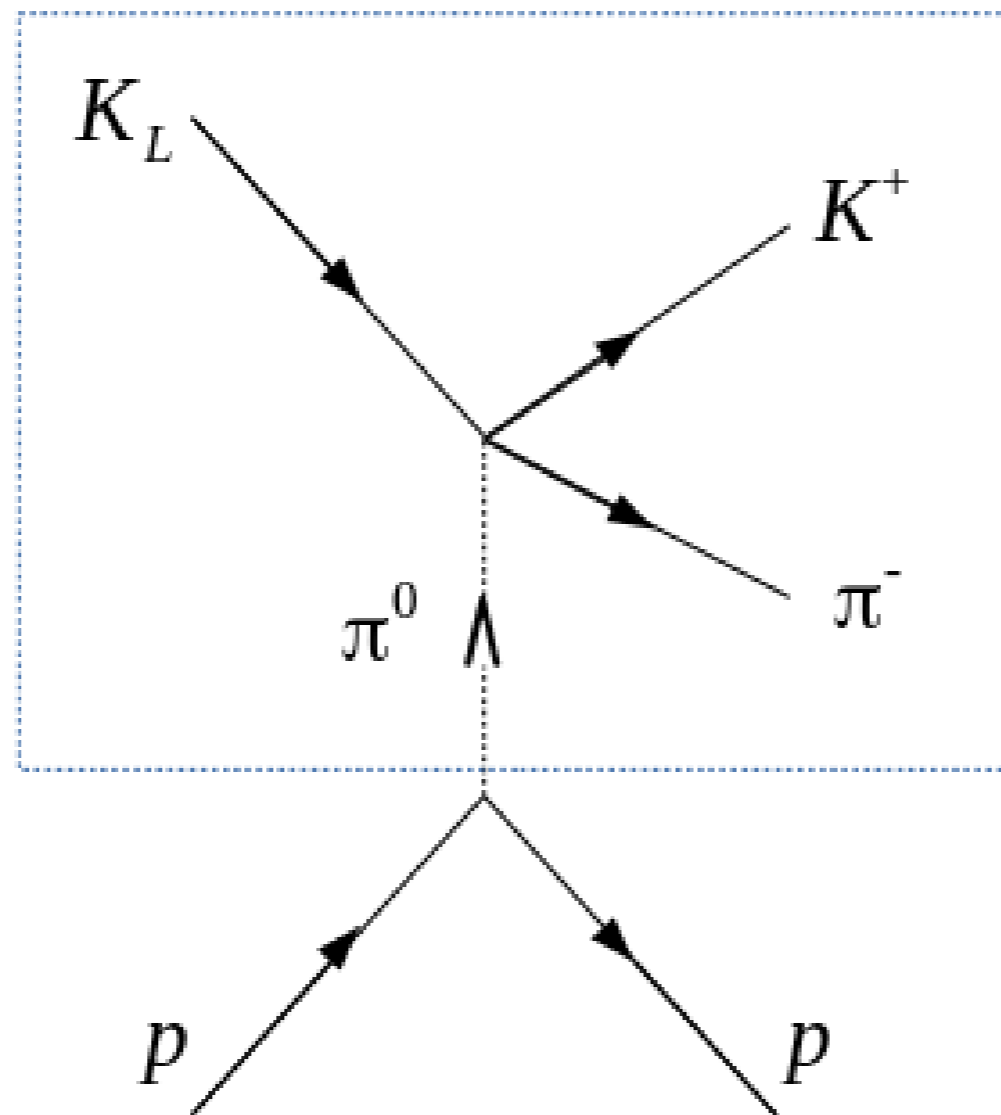
$K\pi$ Scattering



Proposed Measurements

SLAC

$$K^- \pi^+ \rightarrow K^- \pi^+$$

Belle

$$\tau \rightarrow K \pi \nu_\tau$$

KLF

$$K_L \pi^0 \rightarrow K^+ \pi^-$$

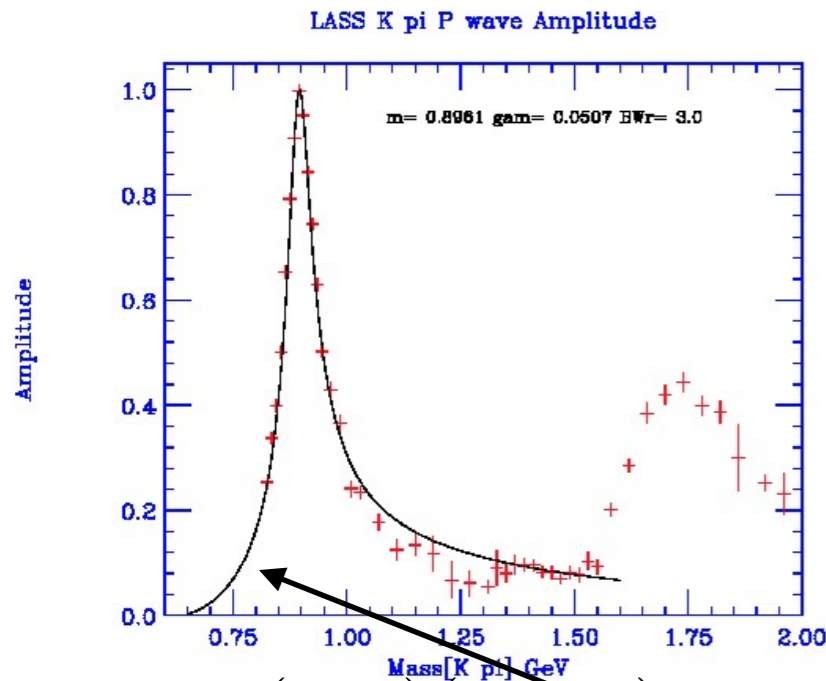

$M(K\pi)$ (GeV)

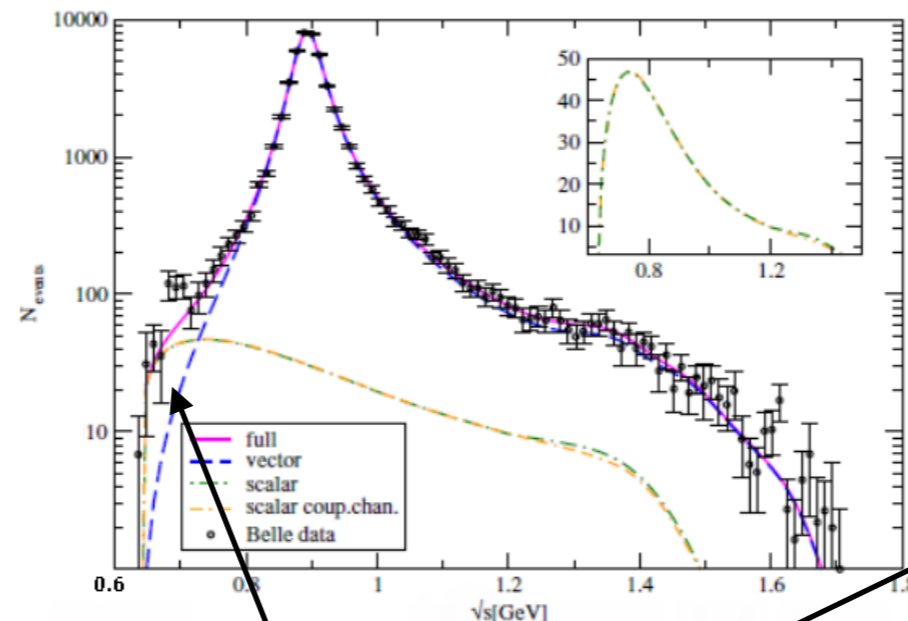

$M(K\pi)$ (GeV)

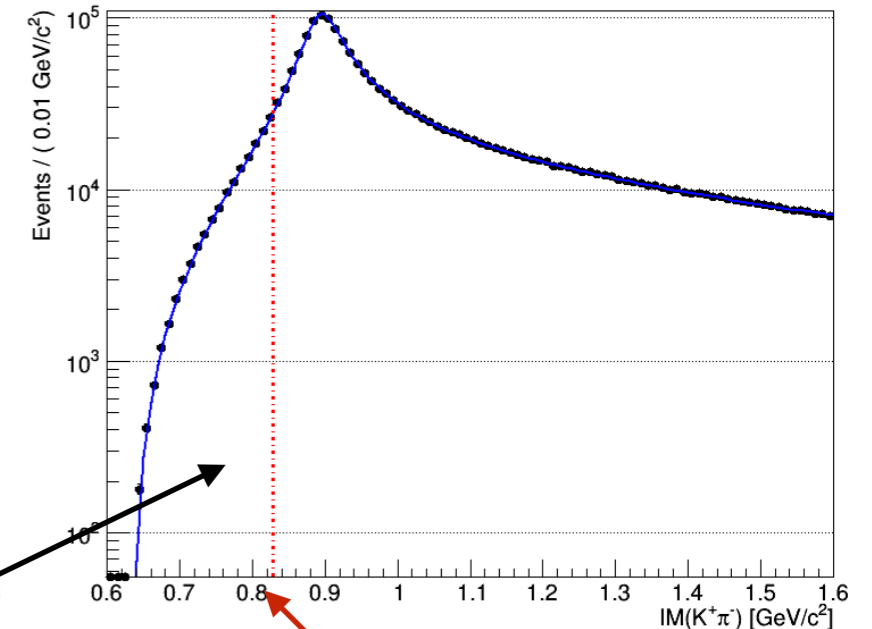

$M(K\pi)$ (GeV)

region of $\mathcal{K}(800)$

SLAC Lower limit

Projected Measurements

$I=3/2+1/2$

S -wave

SLAC Data

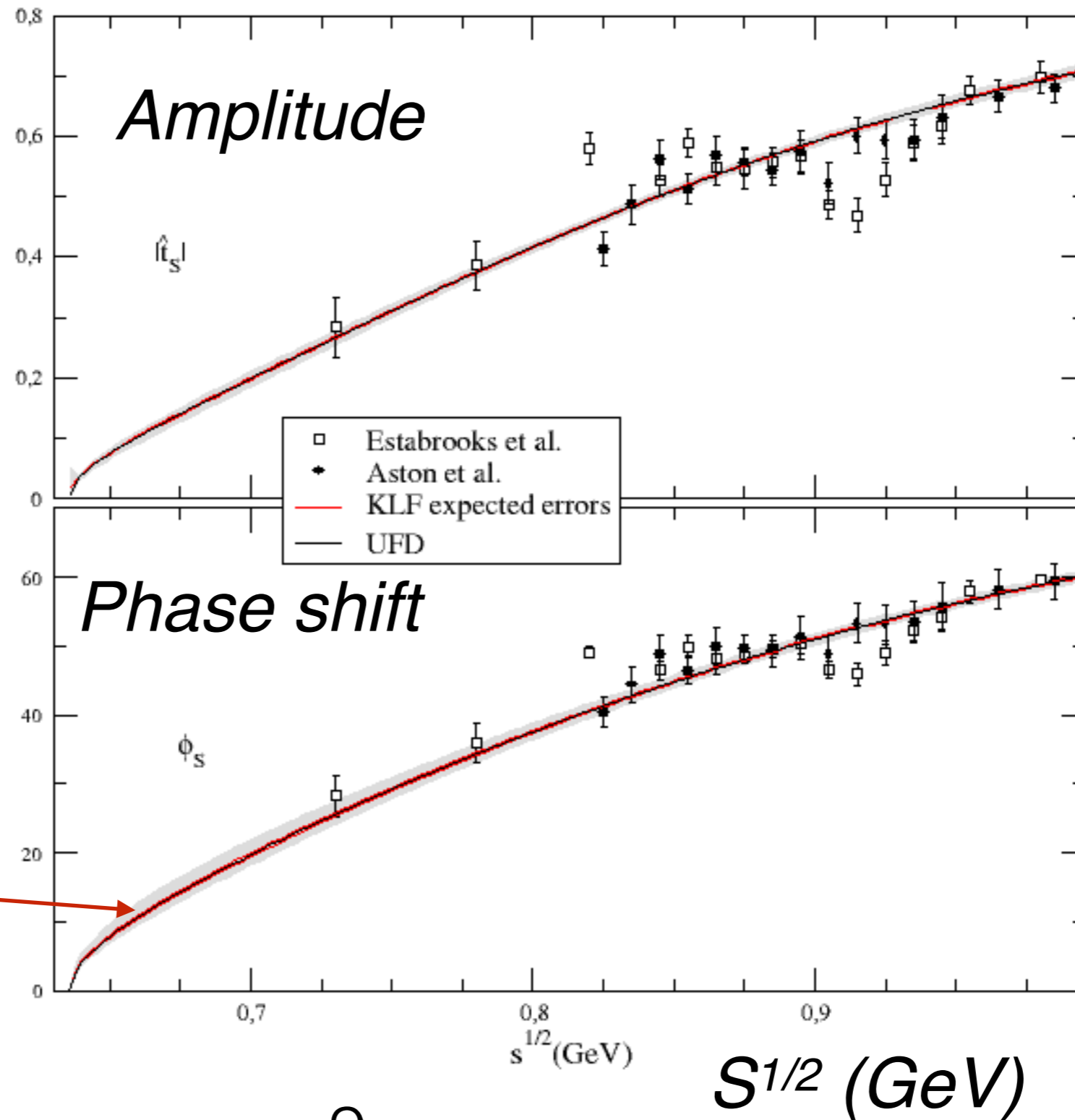

$I=3/2$ S -wave

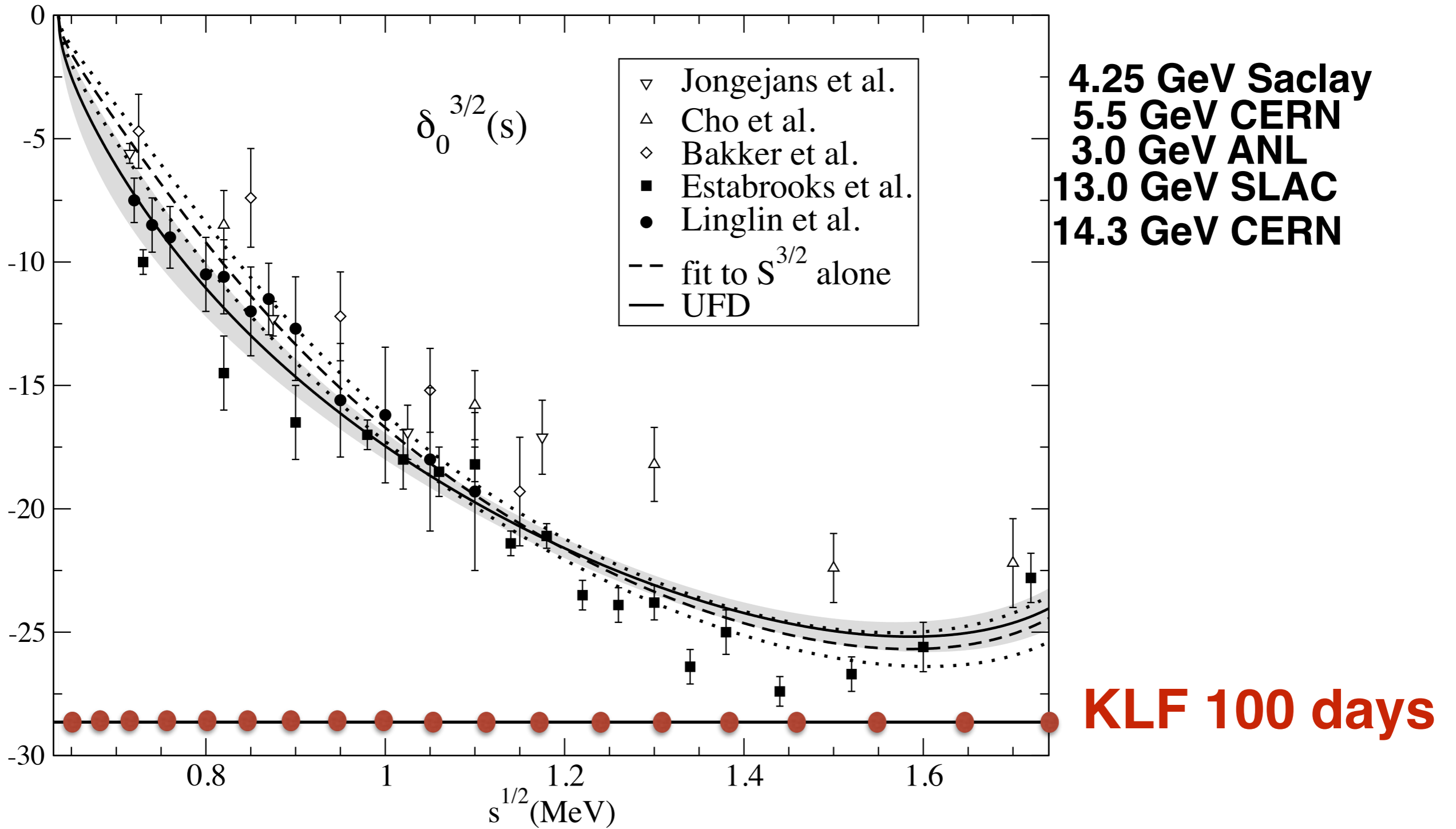

From Pelaez and Rodas paper: PRD93(2016)

Scalar Meson Nonet

$$J^{PC} = 0^{++}$$

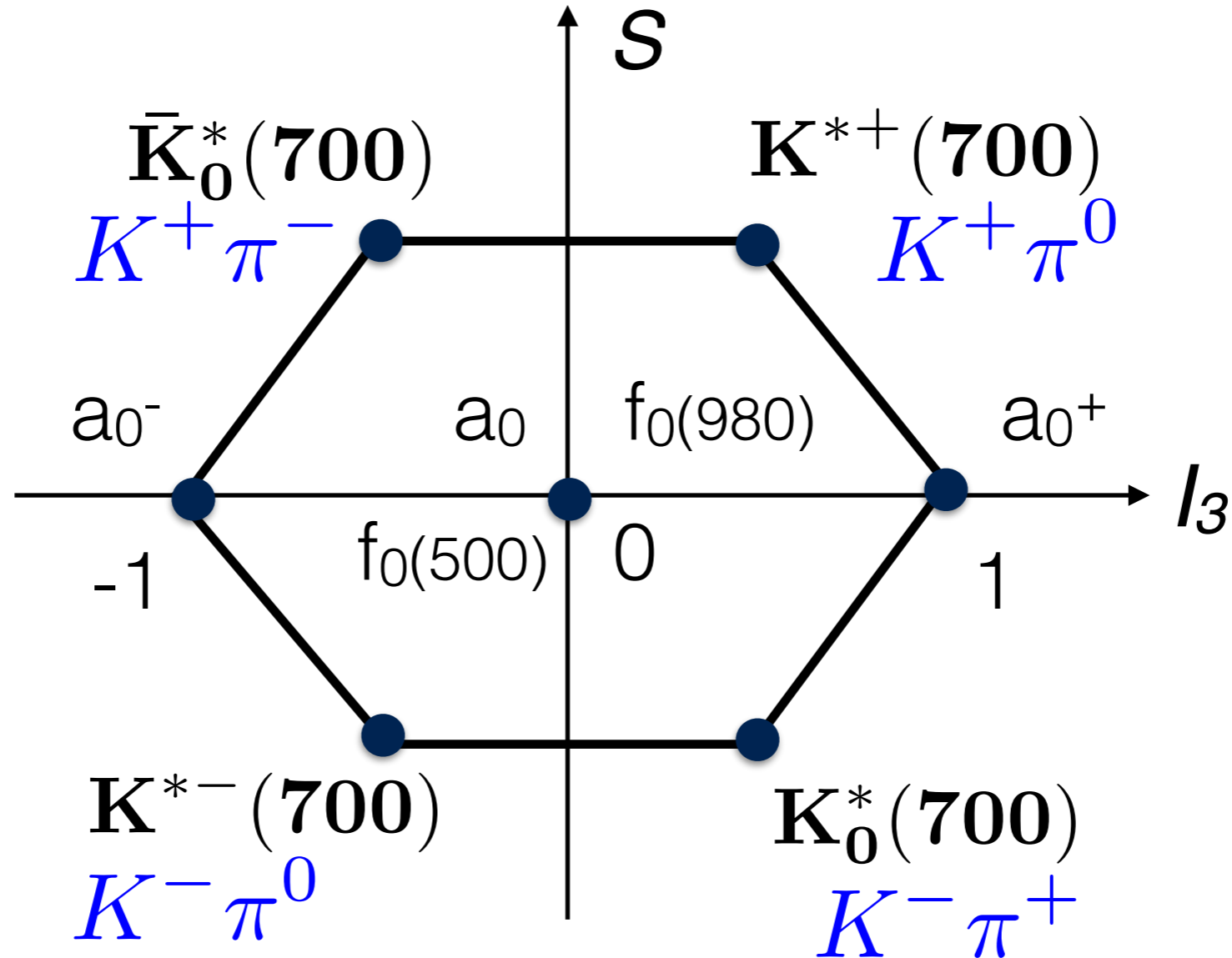

Four states called \mathcal{K}

still need further confirmation(PDG)

We can measure all of them

Width and Mass of κ (800)

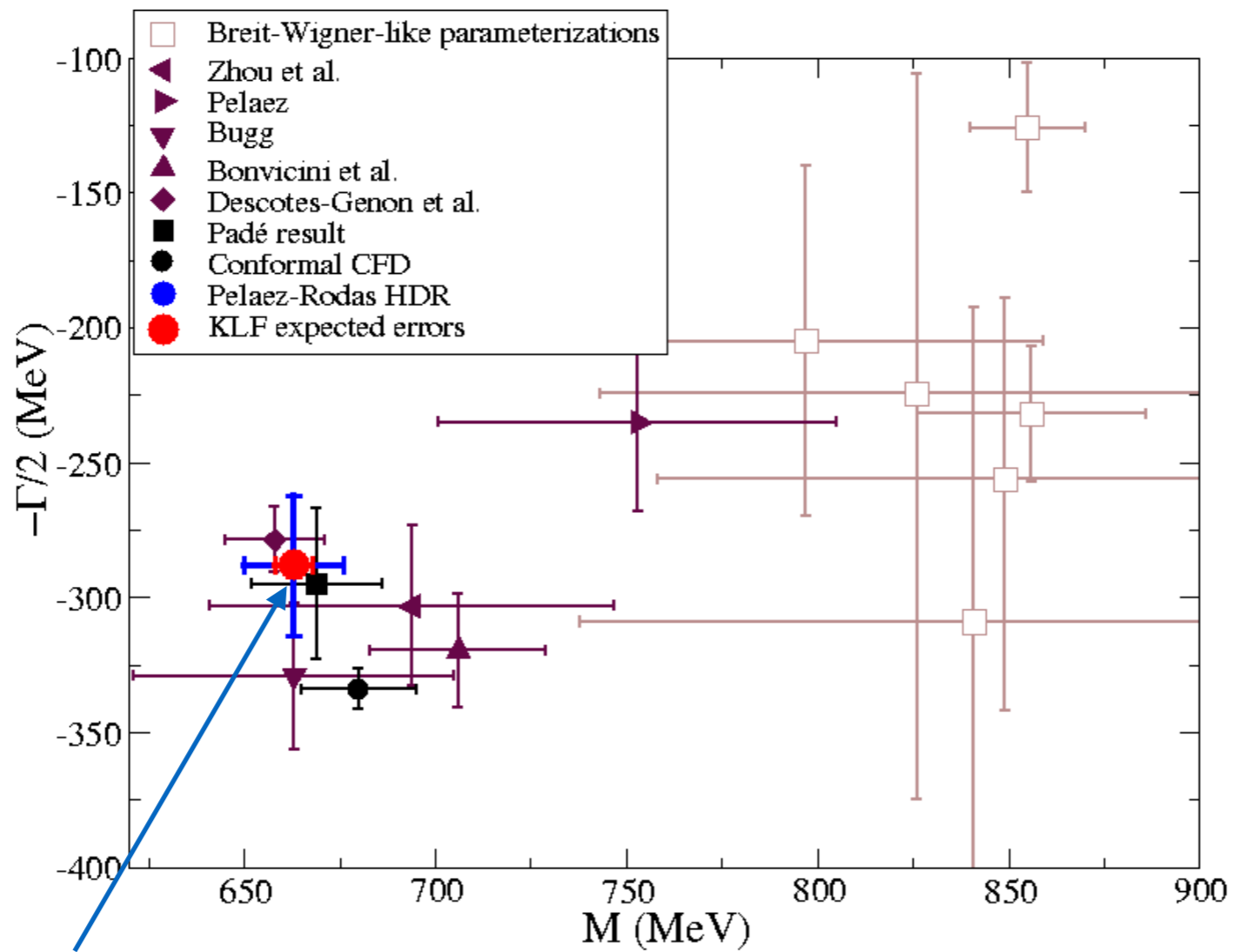

100 days of running

Summary of $K\pi$ Scattering

- The KLF will have a very significant impact on our knowledge on $K\pi$ scattering amplitudes in the scalar $l=1/2$ -channel
- It will certainly improve still conflictive determination of heavy K^* 's parameters
- It will help to settle the tension between phenomenological determinations of scattering lengths from data versus ChPT and LQCD
- Finally, and very importantly, it will reduce by more than a **factor of two** the **uncertainty in the mass determination of $K^*(700)$** and by **factor of five** the **uncertainty on its width, and therefore on its coupling**
- It will clearly resolve the **debate of its existence, and therefore the long standing problem of the existence of the scalar nonet**

Hall-D beamline and GlueX Setup

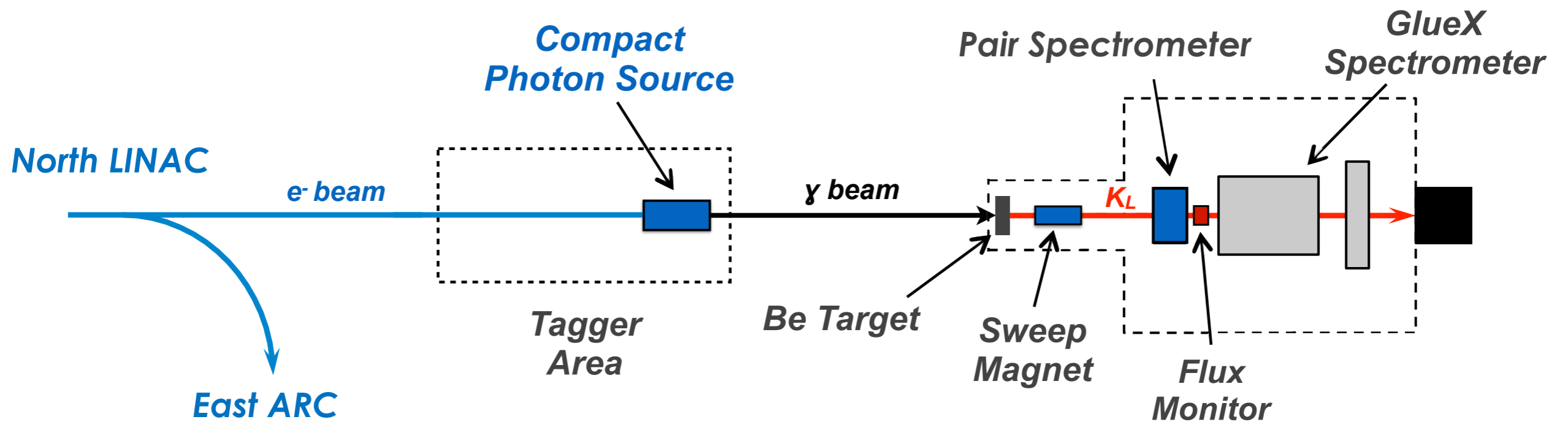

Electron Beam Parameters

$$E_e = 12 \text{ GeV} \quad I = 5 \mu\text{A}$$

$$\text{Bunch spacing} \quad 64 \text{ ns}$$

No major problems.

Doable !

Confirmed by accelerator experts

Compact Photon Source

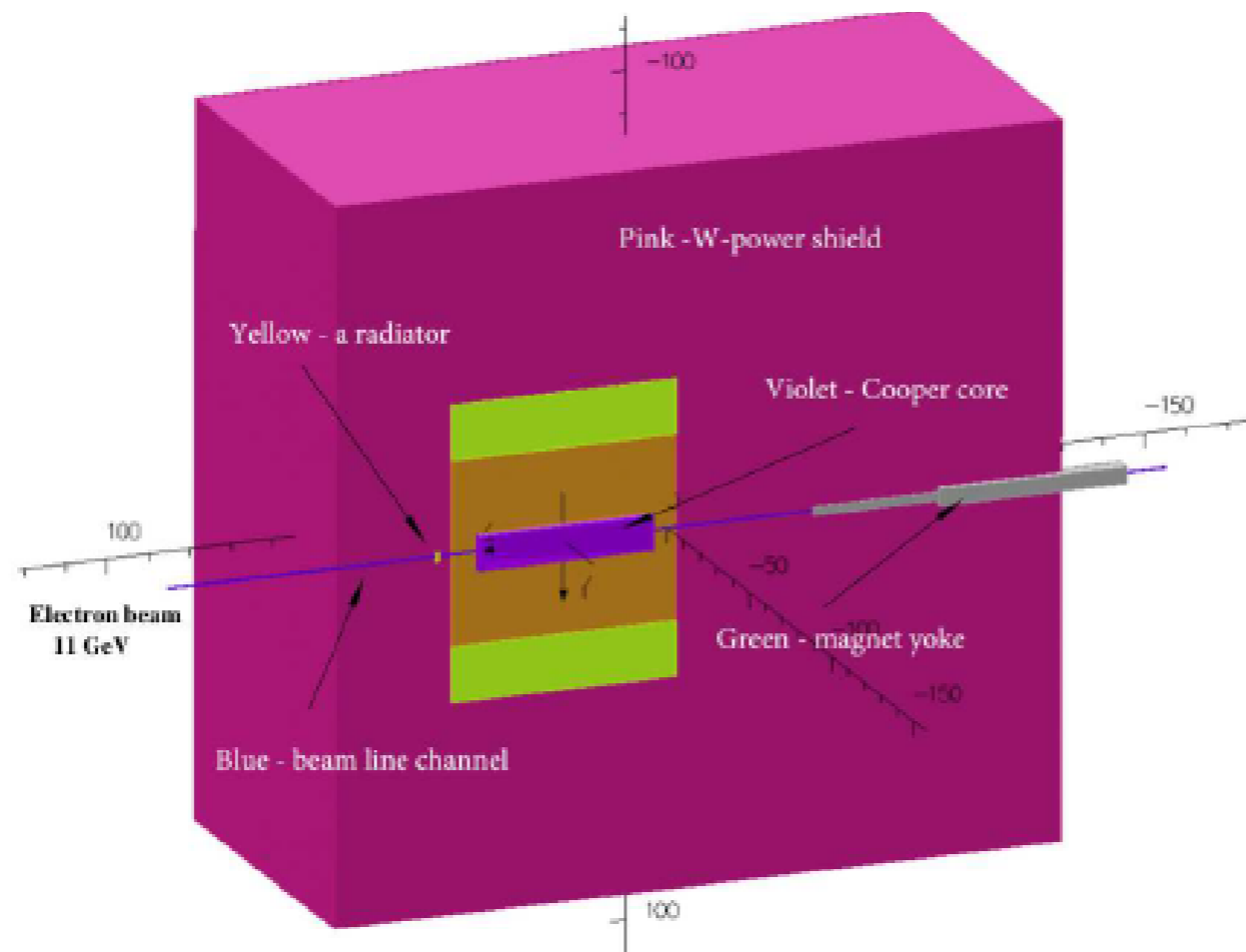

Conceptual design is completed for Halls A&C

The details of the CPS are designed by the CPS Collaboration

Meets RadCon Radiation Requirements

Be Target Assembly: Conceptual Design

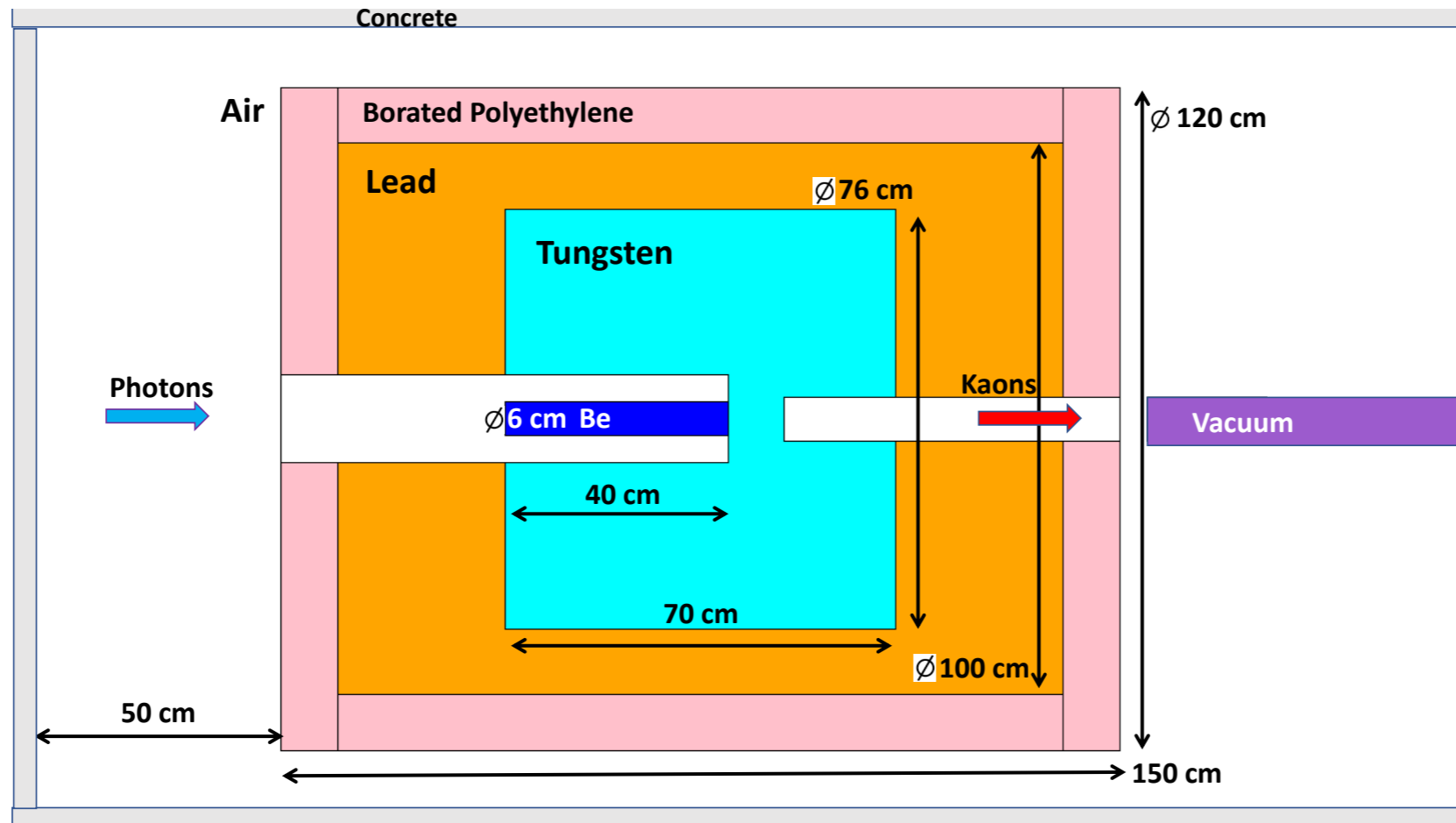

-Meets RadCon Radiation Requirements

-Conceptual Design Endorsed by Hall-D Engineering Staff

Flux Monitor

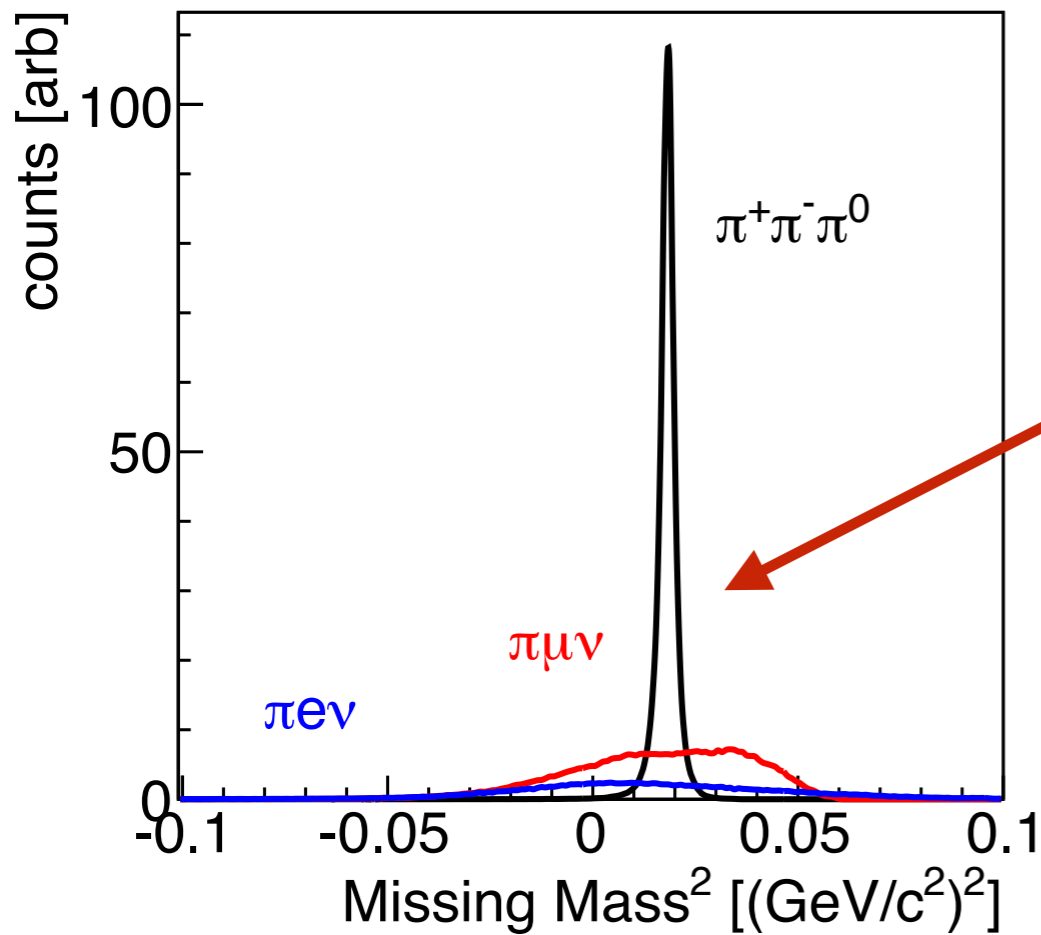
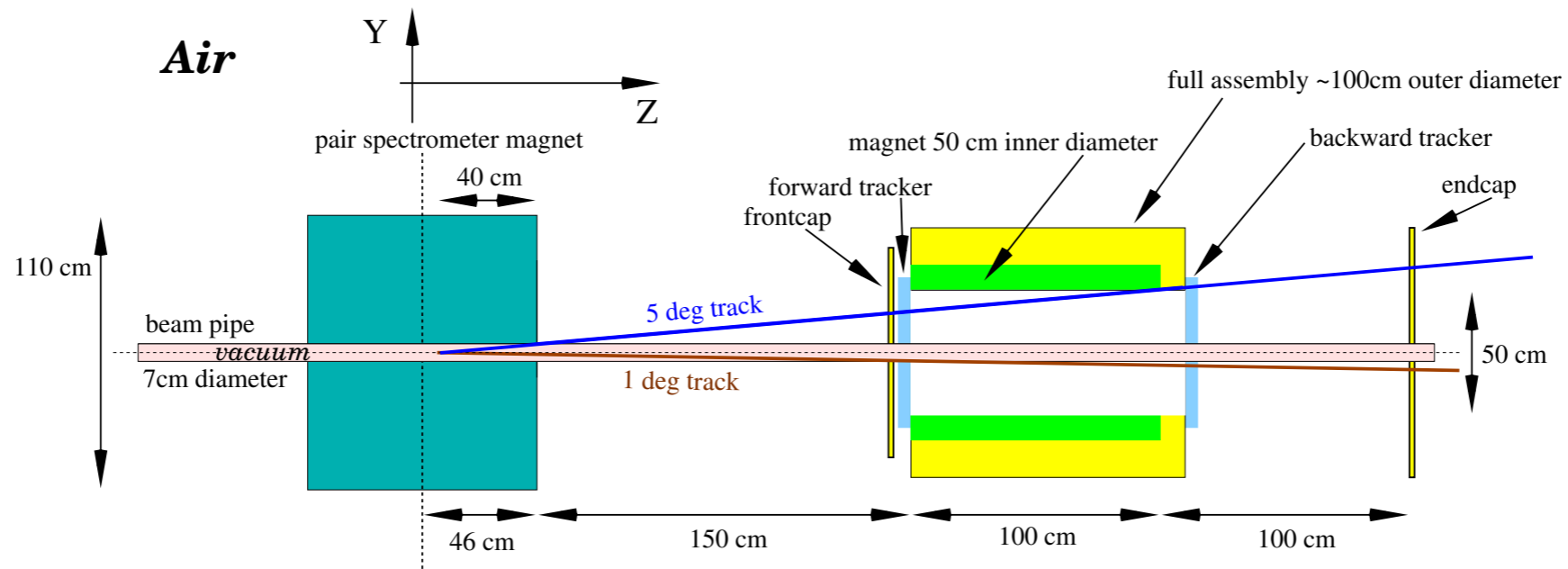

796cm to LH2/LD2 target

Reconstructed K_L mass

Flux measurement stat. err. <1%

Estimated syst. err. ~5%

K_L Beam Flux

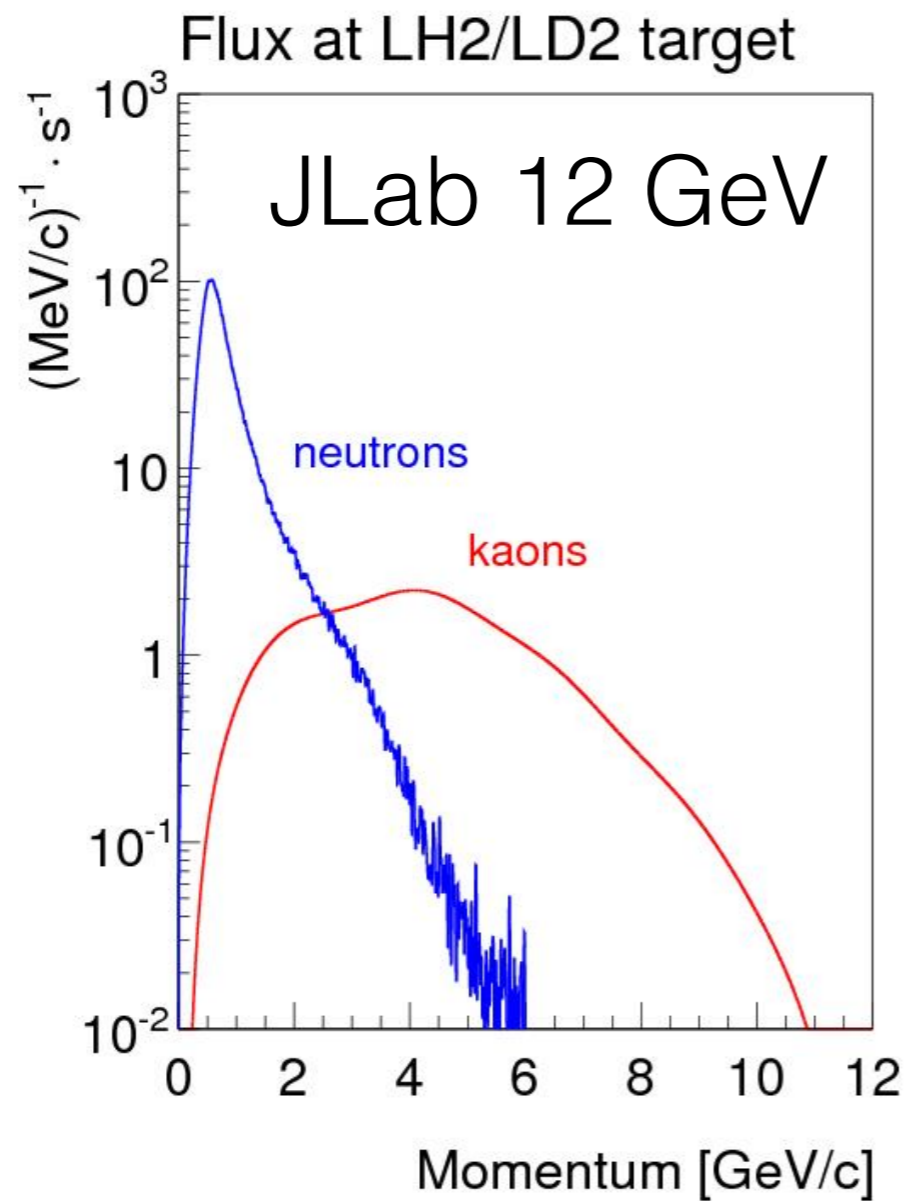

$$N(K_L)/sec \sim 10^4$$

SLAC 16 GeV

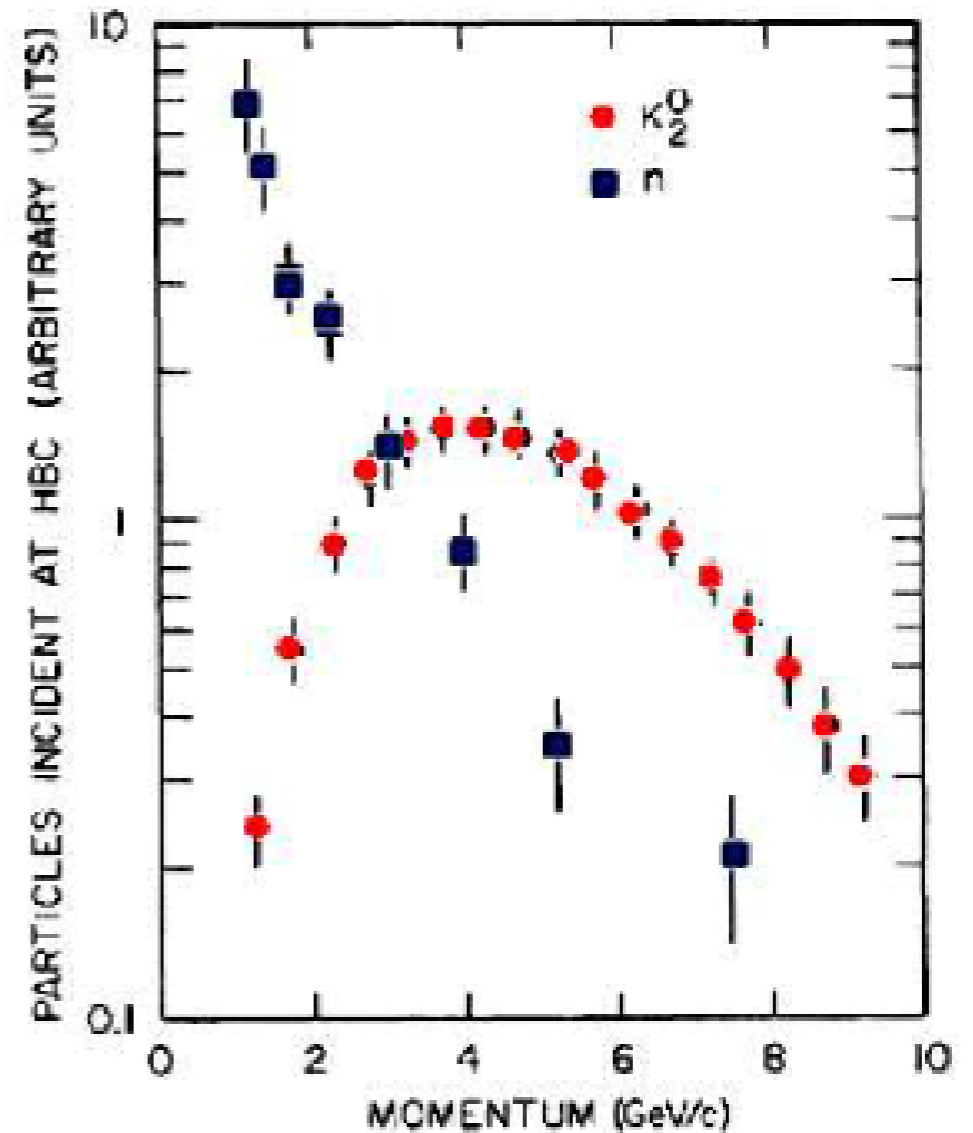

$$\frac{N(K_L)_{JLAB}}{N(K_L)_{SLAC}} \sim 10^3$$

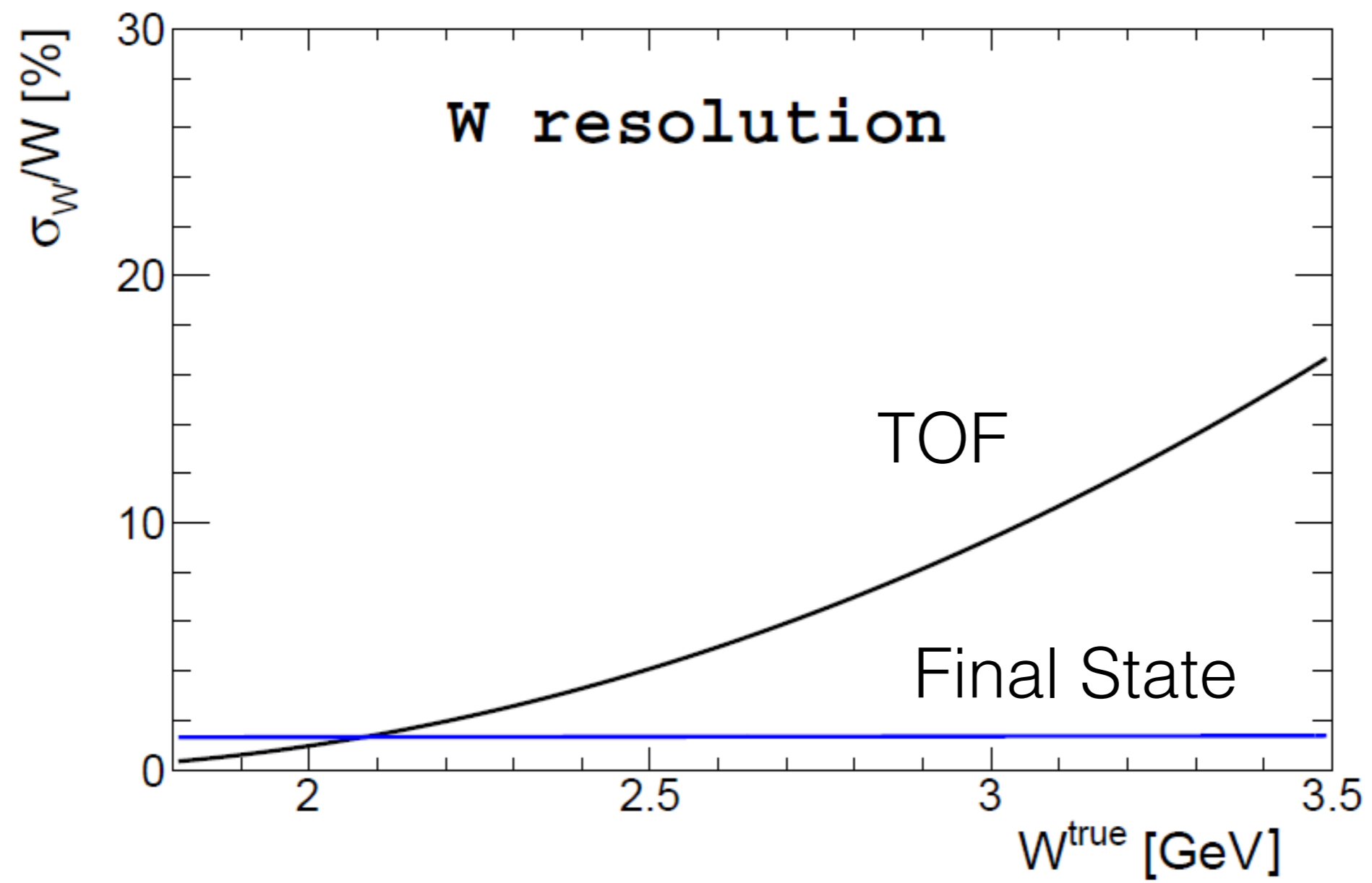

LH₂/LD₂ Cryogenic Target for Neutral Kaon Beam at Hall D

The GlueX liquid hydrogen target.

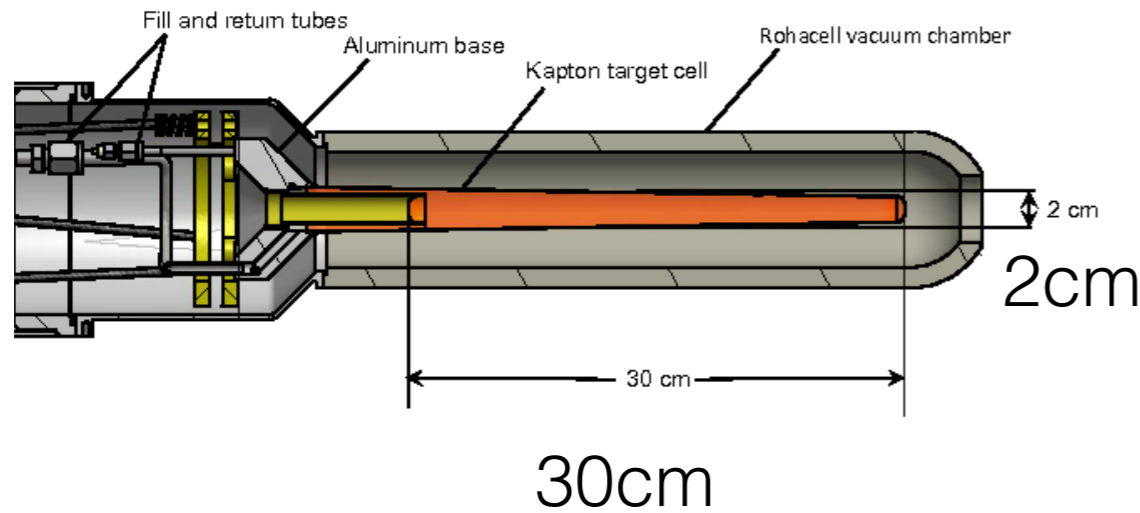

Current

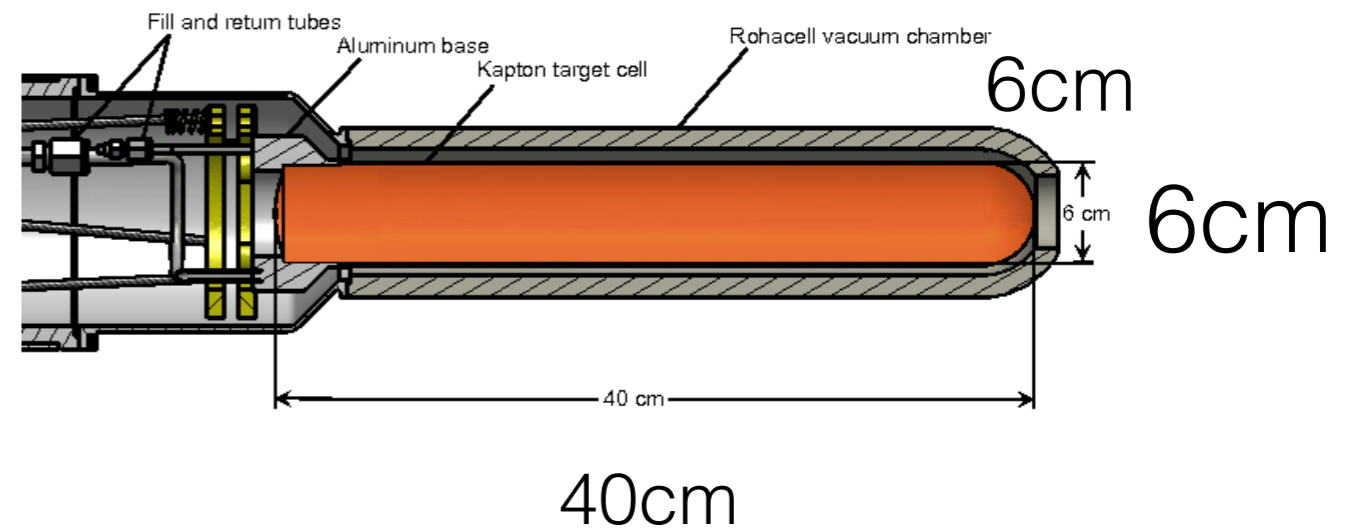

Proposed & Feasible

Longer and thicker target is needed to enhance production rate

Conceptual design has been endorsed by the JLAB target group

$K\pi$ Scattering Resolutions

Four Momentum Resolution for $K_L p \rightarrow K^+ \pi^- p$

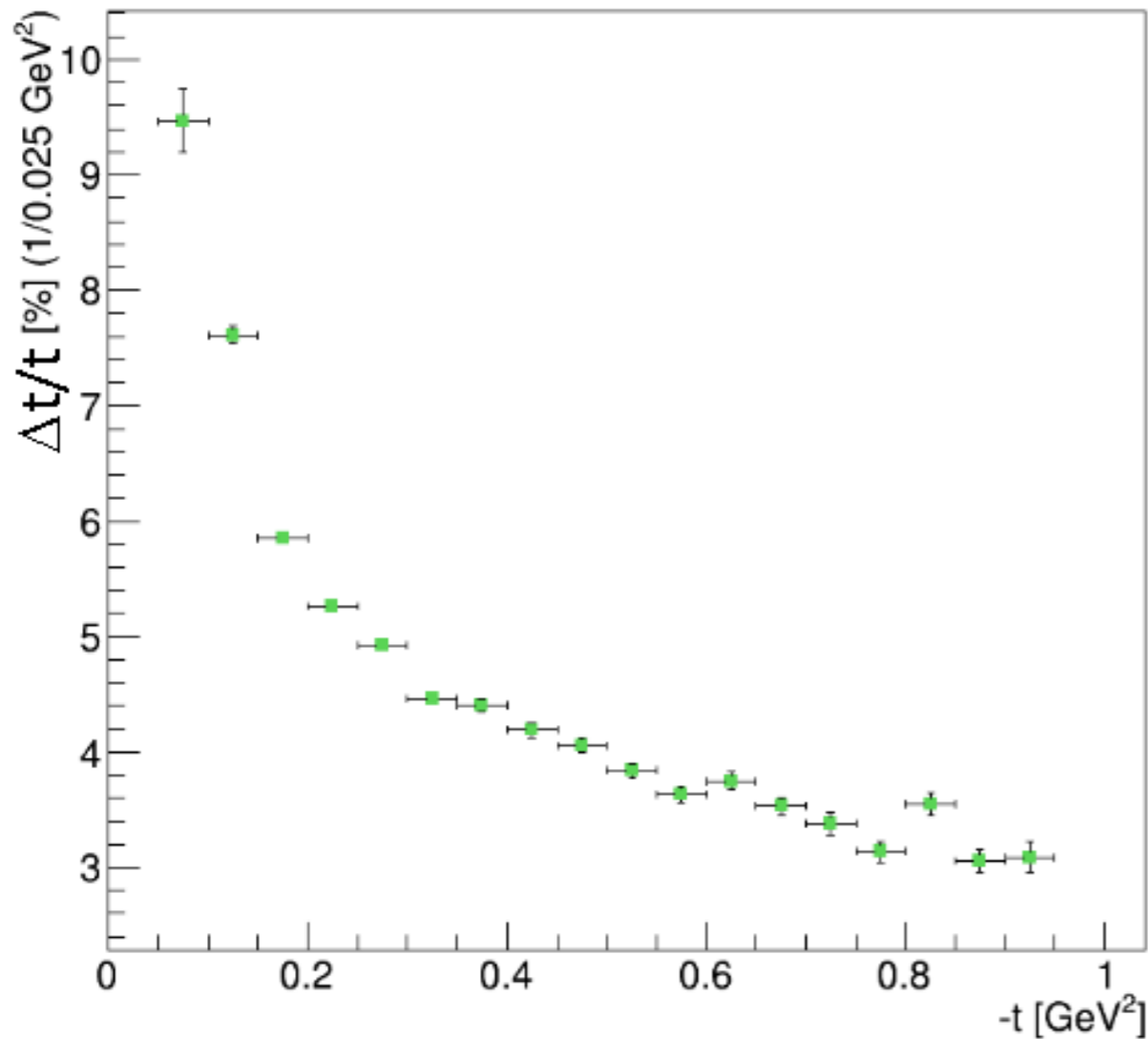

$K^+ \pi^-$ Invariant Mass Resolution for $K_L p \rightarrow K^+ \pi^- p$

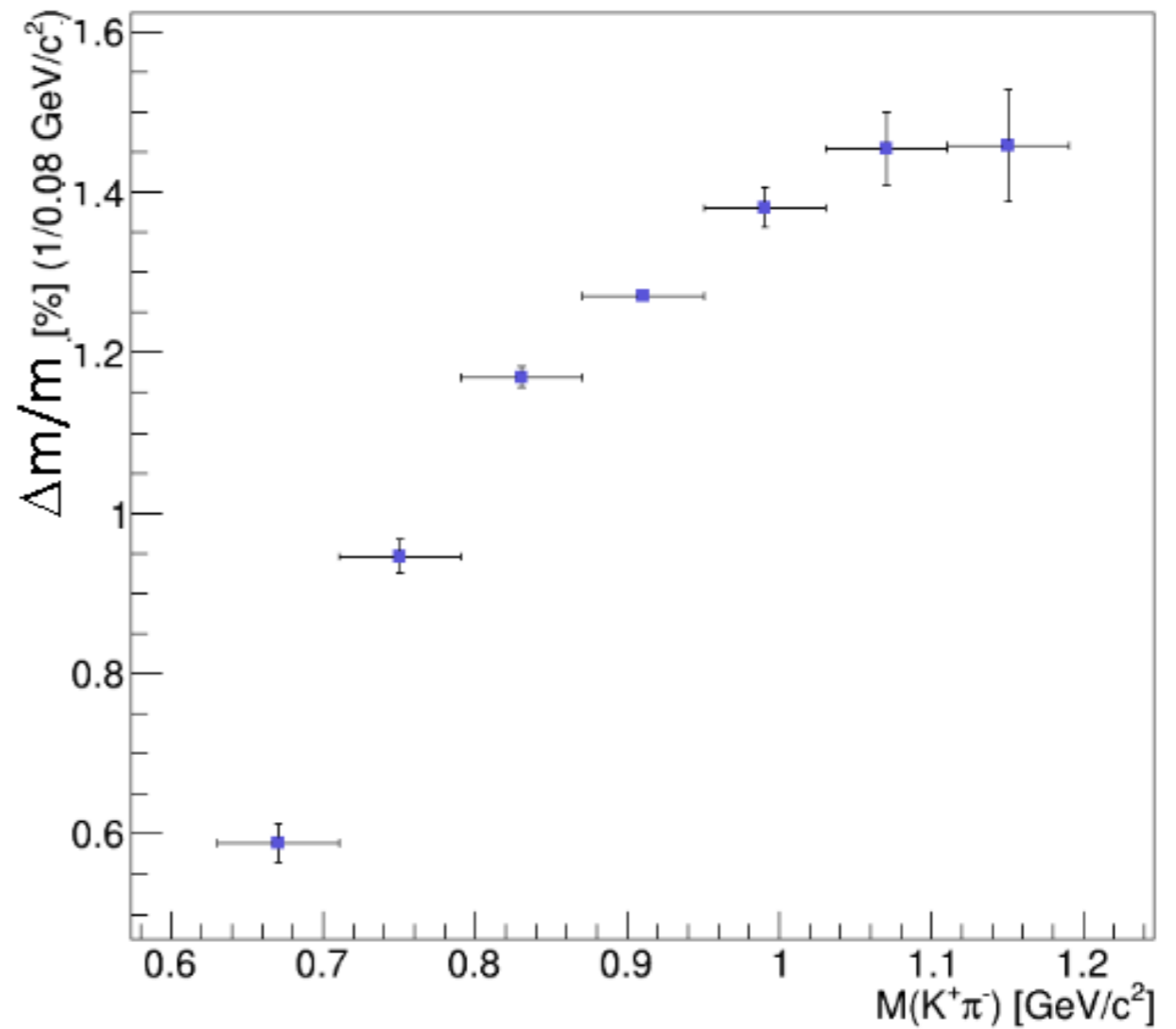

-Good resolution at low- t is needed to be close to pion pole

-Binning in $\sim 10 \text{ MeV}$ will cover almost entire elastic K - π scattering range

PHYSICS WITH NEUTRAL KAON BEAM AT JLAB
KL2016

FEBRUARY 1-3, 2016
JEFFERSON LAB
NEWPORT NEWS, VIRGINIA

SCOPE

The Workshop is following Lo112-15-001 "Physics Opportunities with Secondary KL beam at JLab" and will be dedicated to the physics of hyperons produced by the kaon beam on unpolarized and polarized targets with GlueX set up in Hall D. The emphasis will be on the hyperon spectroscopy. Such studies could contribute to the existing scientific program on hadron spectroscopy at Jefferson Lab.

The Workshop will also aim at boosting the international collaboration, in particular between the US and EU research institutions and universities.

The Workshop would help to address the comments made by the PAC43, and to prepare the full proposal for the next PAC44.

ORGANIZING COMMITTEE

Moskov Amaryan, ODU, chair
Eugene Chudakov, JLab
Curtis Meyer, CMU
Michael Pennington, JLab
James Ritman, Ruhr-Uni-Bochum & IKP Jülich
Igor Strakovsky, GWU

WWW.JLAB.ORG/CONFERENCES/KL2016



YSTAR
Excited Hyperons in QCD
Thermodynamics at Freeze-Out **2016**

NOVEMBER 16-17, 2016

Jefferson Lab
Newport News, Virginia

A workshop to discuss the influence of possible "missing" hyperon resonances (JLab KLF Project) on QCD thermodynamics, on freeze-out in heavy ion collisions and in the early universe, and in spectroscopy. Recent studies that compare lattice QCD calculations of thermodynamic calculations, statistical hadron resonance gas models, and ratios between measured yields of different hadron species in heavy ion collisions provide indirect evidence for the presence of "missing" resonances in all of these contexts. The aim of the workshop is to sharpen these comparisons, advance our understanding of the formation of baryons from quarks and gluons microseconds after the Big Bang and in today's experiments, and to connect these developments to experimental searches for direct, spectroscopic, evidence for these resonances. This Workshop is a successor to the recent KL2016 Workshop

ORGANIZING COMMITTEE

Moskov Amaryan - Chair
ODU
Eugene Chudakov
JLab
Krishna Rajagopal
MIT
Chandia Ratti
University of Houston
James Ritman, Ruhr
U. Bochum & IKP Jülich
Igor Strakovsky
GWU



WWW.JLAB.ORG/CONFERENCES/YSTAR2016/



HIPS 2017

New Opportunities with High-Intensity Photon Sources

February 6-7, 2017
Catholic University of America
Washington, DC U.S.A.

This workshop aims at producing an optimized photon source concept with potential increase of scientific output at Jefferson Lab, and at refining the science for hadron physics experiments benefiting from such a high-intensity photon source. The workshop is dedicated to bringing together the communities directly using such sources for photo-production experiments, or for conversion into K_s beams. The combination of high precision calorimetry and high intensity photon sources can provide greatly enhanced scientific benefit to (deep) exclusive processes like wide-angle and time-like Compton scattering. Potential prospects of such a high-intensity source with modern polarized targets will also be discussed. The availability of K_s beams would open new avenues for hadron spectroscopy, for example for the investigations of "missing" hyperon resonances, with potential impact on QCD thermodynamics and on freeze-out both in heavy ion collisions and the early universe.

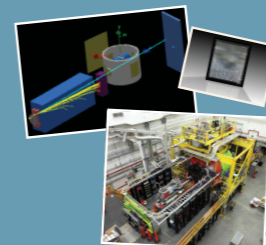

Organizing Committee:

Taule Horn - CUA
Cynthia Keppel - JLab
Carlos Munoz-Camacho - IPNO
Igor Strakovsky - GWU



π-K Interactions
Workshop

ORGANIZING COMMITTEE

Moskov Amaryan, ODU (Chair)
U.-G. Meissner, U. Bonn/IKP Jülich
Curtis Meyer, CMU
James Ritman, Ruhr-Uni-Bochum/IKP Jülich
Igor Strakovsky, GWU

February 14-15, 2018
Jefferson Lab • Newport News, VA

The π-K scattering enables direct investigations of scalar and vector K* states, including the not yet established S-wave K(800) state. These studies are also needed to get precise values of vector and scalar form factors: to independently extract CKM matrix element V_{us} and to test the Standard Model unitarity relation in the first row of CKM matrix, to study CP violation from the Dalitz plot analysis of open charm D meson decays and in a charmless decays of B mesons in Kπ final states. Significant progress is made lately in Lattice QCD, in the phenomenology and in the Chiral Perturbation Theory to describe different aspects of π-K scattering. The main source of experimental data is based on experiments performed in SLAC almost five decades ago at 1970-80s. The recently proposed KL Facility incorporating the GlueX spectrometer at JLab will be able to improve the π-K scattering database by about three orders of magnitude in statistics. The workshop will discuss the necessity for and the impact of the future high statistics data obtained at JLab on π-K scattering.

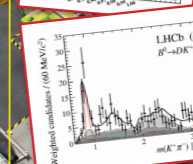
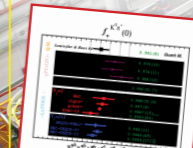
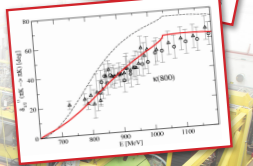
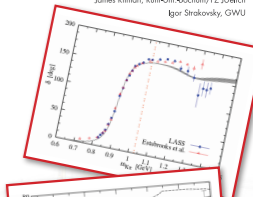

<https://www.jlab.org/conferences/pki2018/>

KL2016

[60 people from 10 countries, 30 talks] <https://www.jlab.org/conferences/kl2016/>
OC: M. Amaryan, E. Chudakov, C. Meyer, M. Pennington, J. Ritman, & I. Strakovsky

YSTAR2016

[71 people from 11 countries, 27 talks] <https://www.jlab.org/conferences/YSTAR2016/>
OC: M. Amaryan, E. Chudakov, K. Rajagopal, C. Ratti, J. Ritman, & I. Strakovsky

HIPS2017

[43 people from 4 countries, 19 talks] <https://www.jlab.org/conferences/HIPS2017/>
OC: T. Horn, C. Keppel, C. Munoz-Camacho, & I. Strakovsky

PKI2018

[48 people from 9 countries, 27 talks] <http://www.jlab.org/conferences/pki2018/>
OC: M. Amaryan, U.-G. Meissner, C. Meyer, J. Ritman, & I. Strakovsky

In total: 222 participants & 103 talks

Proposal:
200 Members
61 Institutions
20 Countries

A. Ali¹⁸, M. B. Ali⁴⁷, M. J. Amaryan^{45,*†}, E. G. Anassontzis², A. V. Anisovich^{4,48},
A. Austregesilo³⁰, M. Baalouch⁴⁵, F. Barbosa³⁰, J. Barlow¹³, A. Barnes⁷, E. Barriga¹³,
M. Bashkanov^{10,†}, A. Bazavov³⁹, T. D. Beattie⁵⁰, R. Bellwied²⁰, V. V. Berdnikov⁸, V. Bernard⁴⁶,
T. Black⁴², W. Boeglin¹², M. Boer⁸, W. J. Briscoe¹⁴, T. Britton³⁰, W. K. Brooks⁵³, B. E. Cannon¹³,
N. Cao²², E. Chudakov³⁰, G. Colangelo³, P. L. Cole²¹, S. Cole¹, O. Cortes-Becerra¹⁴, V. Crede¹³,
M. M. Dalton³⁰, T. Daniels⁴², D. Day⁵⁸, P. Degtyarenko³⁰, A. Deur³⁰, S. Dobbs¹³, G. Dodge⁴⁵,
A. G. Dolgolenko²⁷, M. Döring^{14,30}, M. Dugger¹, R. Dzhygadlo¹⁸, S. Eidelman^{5,44}, R. Edwards³⁰,
H. Egiyan³⁰, A. Ernst¹³, A. Eskandarian¹⁴, P. Eugenio¹³, C. Fanelli³⁶, S. Fegan¹⁴, A. Filippi²⁵,
A. M. Foda⁵⁰, J. Frye²³, S. Furletov³⁰, L. Gan⁴², A. Gasparyan⁴¹, G. Gavalian³⁰,
M. Gauzshtein^{54,55}, N. Gevorgyan⁶¹, C. Gleason²³, D. I. Glazier¹⁷, J. Goity^{30,19},
V. S. Goryachev²⁷, K. Götzen¹⁸, A. Goncalves¹³, L. Guo¹², H. Haberzettl¹⁴,
M. Hadžimehmedović⁵⁷, H. Hakobyan⁵³, A. Hamdi¹⁸, S. Han⁶⁰, J. Hardin³⁶, A. Hayrapetyan¹⁶,
G. M. Huber⁵⁰, A. Hurley⁵⁹, C. E. Hyde⁴⁵, T. Horn⁸, D. G. Ireland¹⁷, M. Ito³⁰, R. Jaffe³⁶,
N. Jarvis⁷, R. T. Jones⁹, V. Kakoyan⁶¹, G. Kalicy⁸, M. Kamel¹², C. D. Keith³⁰, C. W. Kim¹⁴,
F. J. Klein¹⁴, B. Z. Kopeliovich⁵³, C. Kourkoumeli², G. Krafft³⁰, S. Kuleshov⁵³, I. Kuznetsov^{54,55},
A. B. Laptev³³, I. Larin³⁵, D. Lawrence³⁰, D. I. Lersch¹³, H. Leutwyler³, M. Levillain⁴¹, H. Li⁷,
W. Li⁵⁹, K. Livingston¹⁷, B. Liu²², G. J. Lolos⁵⁰, V. E. Lyubovitskij^{56,54,55,53}, D. Mack³⁰,
M. Mai¹⁴, D. M. Manley³¹, M. Mazouz⁴⁷, H. Marukyan⁶¹, V. Mathieu³⁰, M. Matveev⁴⁸,
V. Matveev²⁷, M. McCaughan³⁰, W. McGinley⁷, M. McCracken⁷, J. McIntyre⁹,
U.-G. Meißner^{4,29}, C. A. Meyer⁷, R. Miskimen³⁵, R. E. Mitchell²³, F. Mokaya⁹, V. Mokeev³⁰,
C. Morningstar⁷, B. Moussallam⁴⁶, F. Nerling¹⁸, K. Nakayama¹⁵, Y. Oh³², R. Omerović⁵⁷,
H. Osmanović⁵⁷, A. Ostrovidov¹³, Z. Papandreou⁵⁰, K. Park³⁰, E. Pasyuk³⁰, M. Patsyuk³⁶,
P. Pauli¹⁷, R. Pedroni⁴¹, J. R. Pelaez³⁴, L. Pentchev³⁰, K. J. Peters¹⁸, W. Phelps¹⁴, A. Pilloni³⁰,
E. Pooser³⁰, J. W. Price⁶, N. Qin⁴³, J. Reinhold¹², D. Richards³⁰, D.-O. Riska¹¹, B. Ritchie¹,
J. Ritman^{51,28,†}, L. Robison⁴³, A. Rodas³⁴, D. Romanov³⁷, C. Romero⁵³, J. Ruiz de Elvira³,
H-Y. Ryu⁴⁹, C. Salgado⁴⁰, E. Santopinto²⁴, A. V. Sarantsev^{4,48}, T. Satogata³⁰, A. M. Schertz⁵⁹,
R. A. Schumacher⁷, C. Schwarz¹⁸, J. Schwiening¹⁸, A. Yu. Semenov⁵⁰, I. A. Semenova⁵⁰,
K. K. Seth⁴³, X. Shen²², M. R. Shepherd²³, E. S. Smith³⁰, D. I. Sober⁸, D. Sokhan¹⁷, A. Somov³⁰,
S. Somov³⁷, O. Soto⁵³, M. Staib⁷, J. Stahov⁵⁷, J. R. Stevens^{59,†}, I. I. Strakovsky^{14,†}, A. Švarc⁵²,
A. Szczepaniak^{23,30}, V. Tarasov²⁷, S. Taylor³⁰, A. Teymurazyan⁵⁰, A. Trabelsi⁴⁷, G. Vasileiadis²,
D. Watts¹⁰, D. Werthmüller¹⁷, T. Whitlatch³⁰, N. Wickramaarachchi⁴⁵, M. Williams³⁶,
B. Wojtsekhowski³⁰, R. L. Workman¹⁴, T. Xiao⁴³, Y. Yang³⁶, N. Zachariou¹⁰, J. Zarling²³,
J. Zhang⁵⁸, Z. Zhang⁶⁰, G. Zhao²², B. Zou²⁶, Q. Zhou²², X. Zhou⁶⁰, B. Zihlmann³⁰

SUMMARY

- -Proposed KL Facility has a unique capability to improve existing world database up to three orders of magnitude
- **-In Hyperon spectroscopy**
PWA will allow to unravel and measure pole positions and widths of dozens of new excited hyperon states
- **-In Strange Meson Spectroscopy**
PWA will allow to measure excited K^* states including scalar $K^*(700)$ states
- To accomplish physics program
100 days per LH2 and LD2 is required
- **All components of KL Facility considered are feasible**
-With total cost of the project below \$10M

Thank you !